



Working Together for a
Better Tomorrow. Today.

BID SPECIFICATION PACKAGE

for

BOILER INSPECTION AND REPAIR – FALL 2024 OUTAGE

C133934

Bid Opening Date/Time

Thursday, August 29, 2024 at 2:00 p.m.
City of Grand Island, City Hall
100 East 1st Street, P.O. Box 1968
Grand Island, NE 68802-1968

Contact Information

Tylor Robinson
City of Grand Island – Utilities Department
Platte Generating Station
Email: trobinson@giud.com
Phone: 308/385-5496

Date issued: August 13, 2024

**ADVERTISEMENT TO BIDDERS
FOR
BOILER INSPECTION AND REPAIR-FALL 2024 OUTAGE
CITY OF GRAND ISLAND, NEBRASKA**

Sealed bids for Boiler Inspection and Repair-Fall 2024 Outage will be received at the office of the City Clerk, 100 E. First Street, P.O. Box 1968, Grand Island, Nebraska 68802, until **Thursday, August 29, 2024 at 2:00 p.m. local time**, FOB the City of Grand Island, freight prepaid. Bids will be publicly opened at this time in the Grand Island City Hall City Clerk's Office located on 1st floor of City Hall. **Submit an original and two copies if submitting by mail.** Bid package and any Addendas are also available on-line at www.grand-island.com under Business-Bids and Request for Proposals-Bid Calendar under the bid opening date. Bidding documents, plans and specifications for use in preparing bids may be downloaded from the QuestCDN website www.QuestCDN.com for a \$42.00 fee. Submitting through QuestCDN requires one original document of the bid to be uploaded. **Bids received after the specified time will not be considered.**

The successful bidder will be required to comply with fair labor standards as required by Nebraska R.R.S.73-102 and comply with Nebraska R.R.S. 48-657 pertaining to contributions to the Unemployment Compensation Fund of the State of Nebraska. Successful bidder shall maintain a drug free workplace policy. Every public contractor and his, her or its subcontractors who are awarded a contract by the City for the physical performance of services within the State of Nebraska shall register with and use a federal immigration verification system to determine the work eligibility status of new employees physically performing services within the State of Nebraska.

Each bidder shall submit with the bid a certified check, a cashiers check, or bid bond payable to the City of Grand Island Treasurer in an amount no less than five percent (5%) of the bid price which shall guarantee good faith on the part of the bidder and the entering into a contract within fifteen (15) days at the bid price if accepted by the City. **Your certified check, cashiers check or bid bond must be submitted in a separate envelope attached to the outside of the envelope containing the bid.** Each envelope must be clearly marked indicating its contents. **Failure to submit the necessary qualifying information and correct number of copies in clearly marked and separate envelopes will result in your bid not being opened or considered.** Only surety companies authorized to do business in the State of Nebraska may issue bid bonds.

Bids will be evaluated by the Purchaser based on price, schedule, quality, adherence to schedule, plan and specifications, economy and efficiency of operation, experience and reputation of the bidder, ability, capacity, and skill of the bidder to perform contract required and adaptability of the particular items to the specific use intended.

The Purchaser reserves the right to reject any or all bids, to waive irregularities therein, and to accept whichever bid that may be in the best interest of the City, at its sole discretion.

No bidder may withdraw his/her bid for a period of thirty (30) days after date of bid opening.

Jill Granere, City Clerk

Advertised

(All bids must be submitted on this form)

BOILER INSPECTION AND REPAIR - FALL 2024 OUTAGE
BID DATA FORM

CITY OF GRAND ISLAND
GRAND ISLAND, NE

THE undersigned Bidder, having examined the plans, specifications, general and special conditions, and other proposed contract documents, and all addenda thereto, and being acquainted with and fully understanding all conditions relative to the location, arrangement and specified materials and equipment for the proposed work, HEREBY proposes to provide all necessary supervision, materials, equipment and labor on a time and material basis to support the inspection and repair of steam generator components and auxiliary's equipment as needed during the Platte Generating Station Fall 2024 Outage, FOB the City of Grand Island, freight prepaid, at the following price:

<u>ITEM DESCRIPTION</u>	<u>EXTENDED COST</u>
Base Bid: **	
Material	\$ _____
Labor	\$ _____
Applicable Sales tax*	\$ _____
Total Base Bid	\$ _____

****Bidder shall submit a bid breakdown as defined in Section 3.1 of the Detailed specification on a separate sheet, clearly marked and included as a supplement with the above bid.**

*** If bidder fails to include sales tax in their bid price or takes exception to including sales tax in their bid price, the City will add a 7.5% figure to the bid price for evaluation purposes; however, the City will only pay actual sales tax due.**

Exceptions Noted - Bidder acknowledges there are *Exceptions* and/or *Clarifications* noted to the above bid, and those exceptions are fully explained on a separate sheet, clearly marked, and included with the Bid.

Bidder Company Name Date

Company Address City State Zip

Print Name of Person Completing Bid Signature

Email: _____ Telephone No. _____

According to Nebraska Sales and Use Tax Requirements, Section 1-017, Contractors, check which option you have selected to file with the Nebraska Department of Revenue:

Nebraska law provides a sales and use tax exemption on contractor labor charges for the construction, repair, or annexation of any structure used for the generation, transmission, or distribution of electricity. Separately stated contractor labor would be exempt, all materials are taxable according to the contractor's option.

Option 1 (Section 1-017.05) _____ Option 2 (Section 1-017.06) _____ Option 3 (Section 1-017.07) _____

If the Nebraska sales and use tax election is not filed or noted above, the contractor will be treated as a retailer under Option 1 for sales and use tax purposes.

By checking this box, Bidder acknowledges the Fall maintenance outage is scheduled from September 26, 2024 to October 12, 2024 and work must be completed during this timeframe.

By checking this box, Bidder acknowledges that Addenda Number(s) _____ were received and considered in Bid preparation.

Note: If Bidder supplies individual unit pricing information as supplemental pricing to the base material and labor cost above, said individual pricing is proprietary information and should not be released under a public records request. The total base bid is not considered proprietary information and will be released pursuant to City Procurement Code.

The City reserves the right to reject any bid section(s) submitted by the successful bidder. In submitting the bid, it is understood that the right is reserved by the City to reject any and all bids; to waive irregularities therein and to accept whichever bid that may be in the best interest of the City. It is understood that this bid may not be withdrawn by the bidder until after thirty (30) days from bid opening.

In submitting the bid, the bidder acknowledges the bid guarantee will be forfeited to and become the property of the City of Grand Island, Nebraska, as liquidated damages should this bid be accepted and a contract be awarded to them and they fail to enter into a contract in the form prescribed and to furnish the required bonds within fifteen (15) days, but otherwise the aforesaid bid guarantee will be returned upon signing the Contract and delivering the approved bonds.

Insurance: Bidder acknowledges that their bid includes compliance with the attached insurance requirements.

The Bidder agrees to furnish the required performance and payment bond and to enter into a contract within fifteen (15) days after acceptance of this Bid, and further agrees to complete all work covered by the foregoing bid in accordance with specified requirements. No work shall commence until the Certificate of Insurance and bonds (when required) are approved by the City and the Contract is executed. The proposed work can commence after the Contract is signed and the required bond is approved.

End of Bid Data Form

REQUEST FOR BIDS - GENERAL SPECIFICATIONS

The Bid shall be in accordance with the following and with all attached BID DATA and DETAILED SPECIFICATIONS.

All prices are to be furnished and installed FOB, Grand Island, Nebraska. **All prices shall be firm, and shall include all sales and use taxes as lawfully assessed under laws and regulations of the State of Nebraska.** * If bidder fails to include sales tax in their bid price or takes exception to including sales tax in their bid price, the City will add a 7.5% figure to the bid price for evaluation purposes; however, the City will only pay actual sales tax due.

Mailed bids shall include the following on the **outside** of the mailing envelope: **“Boiler Inspection and Repair-Fall 2024 Outage”**. All bids submitted by mail must include **an original and two copies** of the bid. The bid specification and on-line bidding forms are also available at <http://www.grand-island.com/business/bids-and-request-for-proposals/bid-calendar> under the bid opening date and “Click here for bid document link” through QuestCDN for a \$42.00 fee. If submitting through QuestCDN, **one** original document of the bid is required to be uploaded. No verbal bids will be considered. All sealed bids are due no later than **Thursday, August 29, 2024 at 2:00 p.m. local time.** to:

Mailing Address: City Clerk
City Hall
P. O. Box 1968
Grand Island, NE 68802-1968

Street Address: City Clerk
City Hall
100 E. First Street
Grand Island, NE 68801

Bids will be opened at this time in the City Hall City Clerk’s Office located on 1st floor of City Hall. Any bid received after the specified date will not be considered.

Bids will be evaluated by the Purchaser based on price, schedule, quality, adherence to schedule, plan and specifications, economy and efficiency of operation, experience and reputation of the bidder, ability, capacity, and skill of the bidder to perform contract required and adaptability of the particular items to the specific use intended.

The successful bidder will be required to comply with fair labor standards as required by Nebraska R.R.S.73-102 and comply with Nebraska R.R.S. 48-657 pertaining to contributions to the Unemployment Compensation Fund of the State of Nebraska. Contractor shall maintain a drug free workplace policy. Every public contractor and his, her or its subcontractors who are awarded a contract by the City for the physical performance of services within the State of Nebraska shall register with and use a federal immigration verification system to determine the work eligibility status of new employees physically performing services within the State of Nebraska.

The equipment and materials must be new, the latest make or model, unless otherwise specified. Prior to approving the invoice for payment, the City reserves the right to thoroughly inspect and test the equipment to confirm compliance with specifications. Any equipment or material which does not meet the City's requirements will be returned at vendor's expense for correction. The invoice will be paid after approval at the next regularly scheduled City Council meeting and occurring after departmental approval of invoice; the City Council typically meets the second and fourth Tuesday of each month. Invoices must be received well in advance of Council date to allow evaluation and processing time.

Each bidder shall submit with the bid a certified check, a cashier's check, or bid bond payable to the City of Grand Island in an amount no less than five percent (5%) of the bid price which shall guarantee good faith on the part of the Bidder and the entering into a contract within fifteen (15) days at the bid price if accepted by the City. **Your certified check, cashier's check or bid bond must be submitted in a separate envelope attached to the outside of the envelope containing the original bid.** Each envelope must be clearly marked indicating its contents. **Failure to submit the necessary qualifying information and correct number of copies in clearly marked and separate envelopes will result in your bid not being opened or considered.** Only surety companies authorized to do business in the State of Nebraska may issue bid bonds.

Successful bidder shall comply with the City's insurance requirements; All bids shall be valid for at least thirty (30) working days after the bid deadline for evaluation purposes.

All bids must be on the bid form and must be signed and dated to be accepted. If exceptions and/or clarifications are noted to the bid, those exceptions must be fully explained on a separate sheet, clearly marked, and included with the Bid. Any changes that are found made to the original bid specification, other than Owner generated Addendums, would result in your bid not being considered. Please contact Tylor Robinson at 308-385-5495 or email trobenson@giud.com for questions concerning this specification.

BOILER INSPECTION AND REPAIR

Fall 2024 Outage

Grand Island Utilities Department - Detailed Specification

Contents

- Fall 2024 Outage.....3
- Grand Island Utilities Department - Detailed Specification3
- 1.0 PROJECT DESCRIPTION3
 - 1.1 BACKGROUND.....3
 - 1.2 LOCATION3
 - 1.3 CONTACT3
- 2.0 SCOPE3
 - 2.1 GENERAL.....3
 - 2.2 APPLICABLE CODES AND STANDARDS.....4
 - 2.3 BOILER INSPECTION.....4
 - 2.3.1 Pressure Components.....5
 - 2.3.2 Non-Pressure Components.....5
 - 2.3.3 Boiler Steam Drum.....5
 - 2.3.4 Soot Blower Inspection.....5
 - 2.3.5 Deaerator.....6
 - 2.4 BOILER REPAIRS6
 - 2.4.1 Pressure Components.....6
 - 2.4.2 Non-Pressure Components.....6
 - 2.4.3 Boiler Refractory.....6
 - 2.5 DUCTWORK REPAIRS6
 - 2.6 REPORT7
- 3.0 BIDDING.....7
 - 3.1 MOBILIZATION.....8
 - 3.2 SUPERINTENDENT.....8
 - 3.3 INSPECTION AND REPAIR.....8
 - 3.4 STEAM COIL INSTALLATION.....8
 - 3.5 RATES.....8
 - 3.5.1 Terms and Conditions.....8
 - 3.5.2 Time and Material Accounting.....9
 - 3.6 SUBMITTALS9

3.7 CHANGE ORDERS9
3.8 EXCEPTIONS10
4.0 QUALIFICATIONS.....10
4.1 SUPERINTENDENT.....10
5.0 SAFETY11
6.0 INSURANCE11
7.0 PERFORMANCE AND PAYMENT BOND.....11
8.0 DRAWINGS AND SITE INFORMATION.....11
ATTACHMENTS:11

BOILER INSPECTION AND REPAIR

Fall 2024 Outage

Grand Island Utilities Department - Detailed Specification

1.0 PROJECT DESCRIPTION

1.1 BACKGROUND

The Unit 1 steam generator at Platte Generating Station is a tangential fired, natural circulation, superheat/reheat, pulverized coal-fired boiler manufactured by ABB-CE (CE Contract No. 13477). The steam generator produces 765,000 lb/hr (MCR) of steam at 1000° F and 1800 psi which is delivered to a 100,000 kW steam turbine. The unit uses Powder River Basin Coal from various mines in the basin.

Steam generator auxiliary equipment includes a vertical rotor, Ljungstrom regenerative air heater (type 27-VI-90), a United Conveyor water impounded "W" type bottom ash storage hopper, and four CE-Raymond pulverizers (type 683 RS).

1.2 LOCATION

The Platte Generating Station is located at 1035 W. Wildwood Drive, two (2) miles south of Grand Island, Nebraska. The plant entrance is located two (2) miles south of U.S. Highway 34 and 1 ½ miles east of U.S. Highway 281.

1.3 CONTACT

Question regarding this specification may be directed to:

Tylor Robinson
Platte Generating Station
1035 W. Wildwood Dr.
Grand Island, NE 68801
Ph. (308) 385-5495
trobinson@giud.com

2.0 SCOPE

2.1 GENERAL

This work will generally consist of providing labor, equipment, materials and supervision on a time and material basis to support the inspection and repair of steam generator components and auxiliary's equipment as needed during the Platte Generating Station Fall 2024 Outage, currently scheduled for **September 26, 2024 through October 12, 2024**.

Such work may consist of:

- Hydro testing of the boiler with inspection for tube leaks
- Boiler tube repairs
- Boiler tube surface preparation for UT inspection
- Installation of tube shields

- Repair of boiler tube alignment attachments
- Weld repair of cracks in boiler plate steel
- Weld repair of cracks in flue gas ductwork
- Repair of Boiler Refractory
- Expansion Joint Replacement
- Steam Coil Installation

The Contractor shall cooperate with the Owner's representatives and other contractors on site in maintaining individual work areas, laydown and staging areas, break areas and parking areas as to minimize interference with one another's work efforts. The Contractor shall attend periodic joint scheduling meetings to enhance communications and coordination amongst the various Contractors on site.

The Owner anticipates locating tooling and equipment for boiler work under this specification on the ground level below the boiler inside the plant and throughout all levels of the main boiler and adjacent platforms. A staging and laydown area will be provided at the ground level immediately outside the southeast corner of the unit. A break area will be provided.

The City shall provide the materials mentioned, including all tubing, tube shields and clips, electrical power and electrical connections, and a drinking water source. The Owner shall provide temporary, portable restroom facilities.

The Contractor shall provide required hand tools, hoists, chain falls, cutting torches and gases, welding machines, welding leads and consumables, and all other equipment and materials necessary to completely perform the work.

2.2 APPLICABLE CODES AND STANDARDS

As applicable the following codes and standards in effect on the date of the contract shall be the controlling codes and standards during the period of performance of the contract:

- ASME/BPVC – Power Boilers and Pressure Vessels
- ASME B31.1 – Power Piping
- NBIC – National Board Inspection Code
- AWS – D1.1 and D1.3 Structural Steel
- ASTM – American Society for Testing and Materials
- ASNT – American Society for Nondestructive Testing

2.3 BOILER INSPECTION

Routine inspections of furnace wall tubes, drum, and headers should be made during semi-annual outages.

During the inspection, drums should be opened and hand hole plates removed from headers. The condition of the drum internals should be checked, and internal surfaces inspected for deposits. Tubes should be spot checked, and the tube ends inspected internally for deposits. Where required deposits should be removed and headers, drums and tubes flushed out with clean water.

Furnace tubes should be examined externally for blistering, burning, corrosion, erosion and cracking. Pay close attention to areas surrounding soot blowers as they are susceptible to erosion.

All Inspections shall be thorough and comprehensive. They shall be made by competent personnel, familiar with boiler operation and maintenance. A record of the inspection shall be kept in a uniform manner so that the results of any change can be compared with former conditions.

Inspections of tubes, as a result of tube failures or conditions expected to lead to failures, should be even more thorough.

2.3.1 Pressure Components

The Contractor shall perform visual inspections on the steam generators pressure components as soon as possible so that any problem areas discovered can be evaluated and repaired as required. Inspection process shall consist of but not be limited to:

- Apply a Hydrostatic test in accordance with plant procedures and Boiler Code requirements.
- A visual inspection of boiler tubing. Specifically identify soot blower and ash erosion damage in the 1st, 2nd, 3rd, and 4th tubes in from each soot blower to such extent as feasible.
- Conduct tube thickness testing on the tubes around each soot blower wall opening (four tests, one at each point of the compass) and on every unshielded tube along soot blower paths (one test, in the middle of the path unless a more polished area is observed), including the economizer but not including the horizontal superheater. Review the results with the City to identify any repairs needed immediately and document the results for the City in a report.
- Check elements for alignment and evidence of warping or bulging of unit tubing.

2.3.2 Non-Pressure Components

The Contractor shall perform visual inspections of the steam generators non-pressure components essential to performance and reliability. These duties shall include, but not be limited to:

- Check supports, spacers, alignment bars, and seal plates for proper location and condition.
- Inspect the refractory in all the nose arch, soot blower openings, observation doors, and man way doors.
- Inspect tube shield conditions and document tube shields that need replaced.
- Inspect the refractory and screens in the bottom ash hopper.
- Inspect the Penthouse and all dead air spaces for casing cracks.

2.3.3 Boiler Steam Drum

The contractor shall perform a thorough inspection of the boiler steam drum. The drum inspection shall consist of a visual inspection, checking the drum for corrosion, pitting, or solids carryover. The Contractor shall verify the condition and arrangement of the drum internals.

2.3.4 Soot Blower Inspection

The Contractor shall check for misalignment of the soot blowers, check the depth and travel of all wall blowers, and adjust any soot blowers that are out of specification. The contractor shall pound refractory into the soot blower openings as needed.

2.3.5 Deaerator

The Contractor shall perform routine visual and NDE inspections on the deaerator working components and vessels. Ensure that trays are securely held down and that spray nozzles have adequate tension and are not plugged. Verify that steam box doors swing freely and look for cracks in the steam box.

2.4 BOILER REPAIRS

All repairs shall be done by competent and qualified personnel and all welding shall be in accordance with applicable codes and standards relating to repairing power boilers and pressure vessels.

The Contractor will receive approval from the City's representative for these repairs prior to starting, shall track all repairs and hours, and report status and hours to the City representative daily. Fully document before and after repairs.

2.4.1 Pressure Components

Contractor shall review all recommendations for pressure part repairs with the Owner's Representative. Those repairs authorized by the Owner will be performed by the Contractor and are expected to generally consist of pad welding and partial tube replacements. Those repairs authorized by the Owner will be performed by the Contractor who shall track all repairs and hours, and report status and hours to the City representative daily, fully document before and after repairs.

2.4.2 Non-Pressure Components

Review all repair recommendations with the Owner's representative to determine scopes of repair based on inspection results. Contractor shall perform all repairs authorized by the Owner, including but not limited to:

1. Replace tube shields that are missing. Tube shields will be furnished by the City.
2. Repair damaged alignment bars.
3. Repair dislodged spacer bars.
4. Repair casing cracks in the penthouse and dead air spaces.
5. All other non-pressure component repairs identified and authorized by the Owner.

2.4.3 Boiler Refractory

The contractor shall be responsible for repairing boiler refractory in sootblower openings, observation doors, and man way doors. The contractor will be responsible for repairing the refractory seal where boiler roof tubes and wall tubes meet. Refractory shall be furnished by the contractor.

Refractory shall be a high alumina, phosphate bond plastic refractory, Plibrico SR 90 or approved equal. Approved refractory shall have a service limit of 3400°F, 5cc loss per ASTM C 704 abrasion resistance, and be approved for use in coal fired utility boilers. Refractory shall be installed per manufacturer guidelines.

2.5 DUCTWORK REPAIRS

The Contractor shall be responsible for making weld repairs to the ductwork as required to prevent air in leakage. Ductwork repairs may include welding, patching, and replacing gaskets. The plant has seen an increase in the air in leakage at the precipitator.

2.6 REPORT

The Contractor shall produce a report that in detail describes findings during the inspection of the steam generator. No later than 30 days after project completion, the Contractor shall submit two (2) hard copies and (1) one .pdf file of the report. The Contractor shall document in the report repairs that were completed during the outage. The report shall document the current condition of the boiler during the outage and describe in detail recommended future repairs. The report shall contain subsections of the inspection consisting of, but not limited to:

- Introduction
- Summary and Conclusions
- Recommendations
- Water and Saturated Steam Circuits
 - Economizer
 - Steam Drum
 - Water Wall Tubes
- Superheat and Reheat Circuits
 - Backpass Walls
 - Horizontal Superheat
 - Superheat Pendant Platens
 - Finishing Superheat
 - Reheat Assemblies
- Enclosures
 - Penthouse
 - Nose Arch Dead Air Space
 - Lower Dead Air Spaces
 - Bottom Ash Hopper
- Ductwork
 - Secondary Air Ducts
 - Mill Hot Air Ducts
 - Windbox Ducts
 - Air Preheater
- Pulverizers
 - Pulverizer A
 - Pulverizer B
 - Pulverizer C
 - Pulverizer D
- Precipitator

3.0 BIDDING

The Contractor shall include in his bid a lump sum not-to-exceed estimate of all costs associated with the scope of work herein. This includes, but is not limited to all expenses, equipment, labor, mobilization and demobilization, and subcontractors. Please ensure that all bids contain the following as a minimum:

Bids will be evaluated by the Owner based on price, schedule, quality, economy of operation, experience of contractor, and adherence to specification. The primary evaluation factor will be the lump sum price. The owner reserves the right to reject any or all bids or waive informalities and to accept whichever bid that may be in the best interest of owner, at its sole discretion. **Bids must be received by 2:00 P.M. Thursday, August 29, 2024.**

Bidder is solely responsible for obtaining any clarifications to this specification as may be required for the Bidder to submit an accurate and complete bid proposal.

3.1 MOBILIZATION

The bid shall include a firm price for all Mobilization, Demobilization, Tools, Equipment, Supplies, PPE, Expendables, Supervision, and Project Management, Overhead, Fixed Costs, and Expenses.

3.2 SUPERINTENDENT

The bid shall include a lump sum T&M cost of labor for a Site Superintendent to be available on site 6-days/week, 10 hours per day from **September 26th – October 12th, 2024**. The Superintendent shall be responsible for compiling a report of boiler conditions as described in the scope of work. Actual dates may vary based on outage start date.

3.3 INSPECTION AND REPAIR

The bid shall include a lump sum T&M cost of labor for an inspection and repair crew consisting of 1 BM General Foreman and 3 BM Journeymen to be available on site 6-days/week, 10 hours per day from **September 26th – October 12th, 2024**.

3.4 STEAM COIL INSTALLATION

The bid shall include a not-to-exceed time and material estimated price to install all four (4) sections of the steam coil air heater. The Contractor will be responsible for all labor and materials required to install the steam coil sections and modify the piping and duct work to return the unit to service. The Contractor shall supply all required materials. The Contractor shall complete the scope of work before **October 8th, 2024**.

3.5 RATES

The Bid shall include, as a separate T&M rate attachment, firm unit pricing for all labor, equipment, sundries **and expenses reflecting the charges to be used in billing the T&M portions of the work as well as for making any** adjustments that may be required for new work scope additions, additional services other than what is required in this specification or reductions in the same. All travel time and per diems shall be included in the hourly labor rates. The City of Grand Island will not be responsible for travel expenses to and from plant site. The City of Grand Island will not be responsible for any associated overnight expenses.

3.5.1 Terms and Conditions

Provide all other proposed terms and conditions which will be in effect during the performance of the work as a separate attachment **with the bid**. Any exceptions the bidder wishes to take regarding the Owners specifications and contract documents must be submitted **with the bid**.

Time is of the essence in the evaluation of proposals, the execution of contract documents and/or issuance of a Purchase Order for the execution of the work. Submittal of bids that include terms and conditions unacceptable to the Owner, or that lack the information and clarity required by these specifications may be subject to rejection at the sole discretion of the Owner.

A single contract will be awarded for all work included in this specification.

3.5.2 Time and Material Accounting

Contractor shall be required to maintain accurate job logs describing work performed by each crew throughout each day and daily time sheets detailing all work performed and expenses incurred **in the same format as the bid detail submittal**. Daily time sheets shall identify all individuals by name, craft and all hours worked on each portion of the work. Such job logs and time sheets shall accurately account for all man-hours with clear separation and identification of time, equipment and material as required accounting for the actual service hours and expenses. A sample timesheet shall be included in the bid to be approved by the owner's designated representative.

The timesheets/logs shall clearly detail the specific work that was accomplished during the shift. These sheets shall be presented to the Owner's representative on a daily basis for review with the Contractor's superintendent. Any presentation of timesheets/logs deferred more than 48 hrs. before being presented to the Owner's representative shall be null and void. The Owners representative will sign and date these documents as a record of receipt and review. Any corrections that need to be made to such signed documents shall be implemented upon the discovery of the error and both parties shall initial the change made on the form. These records will then serve as record of the work performed and a basis for determining the final billing.

3.6 SUBMITTALS

Contractor shall submit the following documentation for review with the bid:

- References for at least three (3) projects of a similar scope and for a similar size unit, including a description, name, and phone contact.
- Subcontractor's names and reference lists.
- Copy of Contractor's R stamp.
- Superintendent's experience summary.
- Pricing
- Daily T&M Accounting Sheets
- Safety Documentation

3.7 CHANGE ORDERS

If any extra and/or additional work is to be done or any change in the plans and specifications is deemed necessary, the Purchaser may issue the Contractor a written change order directing that such extra work be done or that such change be made, and the Contract shall be modified accordingly. No claim for extra costs shall be allowed in the absence of a written change order. The Contractor shall give prompt written notice of any matter which they believe to involve extra cost. In the absence of such notice by the Contractor on account thereof his right to such claim shall be deemed to have been waived. Compensation to the Contractor will be calculated as an addition to or deduction from the Contract Price, based upon such written terms as may be established between the parties, either (a) by an acceptable lump sum proposal of the Contractor, or (b) on a cost-plus limited basis not to exceed a specified limit, or (c) on a basis of the unit prices as stated in these specifications where such unit prices apply. In the event that none of the foregoing methods are agreed upon with the Contractor, the Purchaser may perform the work. The Purchaser shall be the sole judge of such action and procedure. Determination of cost-plus work shall be based upon actual cost of labor and material plus a maximum of 20% of actual Contractor cost for overhead, profit,

The Contractor shall submit a formal process for addressing work that may arise but is not described herein. All change orders shall be addressed with a detailed scope of work and approved before proceeding with scope of extra work.

Contractor shall be required to maintain accurate job logs describing work performed by each crew throughout each day and daily time sheets detailing all work performed and expenses incurred **in the same format as the bid detail submittal**. Daily time sheets shall identify all individuals by name, craft and all hours worked on each portion of the work. Such job logs and time sheets shall accurately account for all man-hours with clear separation and identification of Time, equipment and Material as required accounting for the actual service hours and expenses. A sample timesheet shall be included in the bid to be approved by the owner's designated representative.

3.8 EXCEPTIONS

The purpose of this specification is to give detail on conditions under which the new equipment will operate, scope of Contract, quality of equipment required, standards used in determining its acceptability and similar data. Each bidder shall carefully read all requirements herein set forth and shall offer equipment and services which fully comply with these requirements or shall plainly set forth all points, features, conditions, specifications, etc., wherein the equipment offered does not meet these specifications. Such exceptions as are made shall be listed by section and subsection number and shall be marked in ink in the sections of these specifications. Exceptions shall be explained in detail in a letter accompanying the bid. References shall not be made to the bidder's Proposal for exceptions and supplementary terms. Failure to outline such exceptions will require the successful bidder to comply with these specifications.

The Platte Generating Station is NOT tax exempt and is subject to 7.5% sales tax. See the Nebraska Department of Revenue web site at www.revenue.state.ne.us for contractor's tax information.

4.0 QUALIFICATIONS

The Contractor shall be a firm specializing in the installation, overhaul, repair, and maintenance of steam generating equipment used in the power generation industry. The Contractor shall be capable of fully performing the work without the assistance of City personnel, except as required for the City to identify specific repair locations. A reference list of projects of similar scope and complexity shall be provided with the bid. The Contractor shall possess a valid ASME "R" stamp and valid welding procedures as typical for utility boilers and as specifically required for welds required in these specifications. All welders shall be certified as required for the work performed and the certification documents shall be available to review at the job site. Prior to award, the Contractor shall submit procedures for all welding required in this specification to the City for review.

4.1 SUPERINTENDENT

The Contractor shall provide well qualified Job Superintendent who will fully direct all field operations for the duration of the project, serve as liaison to the Owner's designated representatives, be fully authorized to make any and all decisions affecting the work in the field and coordinate activities between the Contractor and its subcontractors, if any. The Superintendent shall be thoroughly familiar with Combustion Engineering tangential boilers and auxiliary equipment and have had previous experience with projects of similar scope. A summary of the experience of the Superintendent proposed for this project shall be **provided with the bid**.

5.0 SAFETY

The Contractor shall be responsible for compliance with all safety practices as required by the regulatory agencies governing the Contractor's operations as well as any safety requirements of the Contractor's organization and shall submit historical evidence of such compliance. All personnel working on site will be required to participate in the plant's safety orientation prior to performing any work on site at PGS.

The plant has an equipment lockout/tag out procedure to prevent the unauthorized starting of motors and the unauthorized movement of valves and dampers. The Contractor is required to use the procedure and add its own locks/tags on top of the plant lock/tags if required. *Removal of plant locks/tags is not allowed and is cause for removal from the plant site.*

6.0 INSURANCE

The contractor shall comply with the attached City's insurance requirements.

7.0 PERFORMANCE AND PAYMENT BOND

The successful Bidder shall file with the OWNER Performance and Payment Bonds in the full amount (100 percent) of the Contract price, as security for the faithful performance of the Contract and the payment of all persons supplying labor and materials for the Work under this Contract, and to cover all guarantees against defective workmanship or materials, or both, for a period of 1 year after the date of final acceptance of the Work by the OWNER. The Surety furnishing these bonds shall have a record of service satisfactory to the OWNER, be authorized to do business in the State where the OWNER's project is located and shall be named on the current list of approved Surety Companies, acceptable on Federal bonds as published by the Audit Staff, Bureau of Accounts, U.S. Treasury Department.

The Attorney-in-Fact (Resident Agent) who executes these bonds on behalf of the Surety must attach a notarized copy of his power-of-attorney as evidence of his authority to bind the Surety on the date of execution of the bond.

8.0 DRAWINGS AND SITE INFORMATION

A selection of drawings has been provided with the bid package for reference only. Additional drawings are available for review at Platte Generating Station office. The Contractor is responsible for making such pre-bid site visits as required to obtain additional details for bidding and execution of the work and for clarification of any questions or concerns the bidder may have related to the work scope and site conditions.

ATTACHMENTS:

40-195	Boiler Elevation
Figure 1	Boiler General Arrangement
13477-4E-0301	Valve Operating Diagram
13477-4C-1292	Boiler Tube Material Diagram
13477-4C-1291	Boiler Tube Material Diagram
13477-4C-1290	Boiler Tube Material Diagram
77-8-P1	Flow Diagram Legend
77-8-P3	Flow Diagram EX-Extraction Steam
77-8-P34	Flow Diagram AR-Air Removal & SC-Steam Coil Drains

EX-4	Intermediate Extraction Detail
83-CD-4231	Steam Coil Assembly
83-CD-4233	Steam Coil Suggested Piping Diagram
SC-1	Steam Coil Piping Diagram 1
SC-2	Steam Coil Piping Diagram 2
SC-3	Steam Coil Piping Diagram 3
SC-4	Steam Coil Piping Diagram 4
SC-5	Steam Coil Piping Diagram 5

INSTRUCTIONS TO BIDDERS

1. GENERAL INFORMATION.

The following instructions outline the procedure for preparing and submitting Bids. Bidders must fulfill all requirements as specified in these Documents.

2. TYPE OF BID.

Bidders shall be required to submit prices for all items listed in the Bid Data Form.

3. PREPARATION OF BIDS.

Bidders shall use only the Bid Data Form provided in these Documents. All blank spaces in the Bid Data Form must be filled in, preferably in BLACK ink, in both words and figures where required. No changes to the wording or content of the forms is permitted. Written amounts shall govern in case of discrepancy between the amounts stated in writing and the amounts stated in figures.

Prices stated shall be f.o.b. with freight and full insurance paid by Bidder, to the job site located in Grand Island, Nebraska.

The Bidder shall acknowledge receipt of all Addenda in the Bid Data Form. Bids received without acknowledgement or without the Addendum enclosed will be considered informal.

Individual unit pricing as listed on the Bid Data Form or supplied as supplemental information may be deemed proprietary information and not be released under a public records request. The total amount of the bid is not considered proprietary information and will be released pursuant to City Procurement Code.

4. SUBMISSION OF BIDS.

All Bids must be submitted intact with the correct number of copies no later than the time prescribed, at the place, and in the manner set forth in the ADVERTISEMENT FOR BIDS. Bids must be made on the Bid Data Form provided herein. Each Bid mailed must be submitted intact in a sealed envelope, so marked as to indicate its contents without being opened, and delivered in person or addressed and mailed in conformance with the instructions in the ADVERTISEMENT FOR BIDS.

5. BID SECURITY.

Bids must be accompanied by cash, a certified check, or cashier's check drawn on a bank which is insured by the Federal Deposit Insurance Corporation, or a bid bond issued by a Surety authorized to issue such bonds in the state where the Work is located, in the amount of 5 percent of the bid amount payable to OWNER. This bid security shall be given as a guarantee that the Bidder will not withdraw their Bid for a period of thirty (30) days after bid opening, and that if awarded the Contract, the successful Bidder will execute the attached Contract within the time specified.

The Attorney-in-Fact that executes this bond on behalf of the Surety must attach a notarized copy of his/her power of attorney as evidence of his/her authority to bind the Surety on the date of execution of the bond. Where State Statute requires, certification by a resident agent shall also be provided.

6. RETURN OF BID SECURITY.

Within fifteen (15) days after the award of the Contract, the OWNER will return the bid securities to all Bidders whose Bids are not to be further considered in awarding the Contract. All other retained bid securities will be held until the Contract has been finally executed, after which all bid securities, other than Bidders' bonds and guarantees which have been fortified, will be returned to the respective Bidders whose Bids they accompanied.

7. BASIS OF AWARD.

The award will be made by the OWNER on the basis of the Bid from the lowest responsive, responsible Bidder which, in the OWNER's sole and absolute judgment will best serve the interest of the OWNER. All Bids will be considered on the following basis:

- Delivery time
- Bid price
- Cost of installation
- Suitability to project requirements
- Conformance with the terms of the Bid Documents

- Responsibility and qualification of Bidder

The OWNER reserves the right to reject all Bids, or any Bid not in conformance with the intent of the Bid Documents, and to waive any informalities and irregularities in said Bids.

8. EXECUTION OF CONTRACT.

The successful Bidder shall, within fifteen (15) days after receiving notice of award, sign and deliver to the OWNER the Contract hereto attached together as required in these Bid Documents. Within fifteen (15) days after receiving the signed Contract from the successful Bidder, the OWNER's authorized agent will sign the Contract. Signature by both parties constitutes execution of the Contract.

9. TIME OF COMPLETION.

The time of completion of the Work to be performed under this Contract is the essence of the Contract. The time allowed for the completion of the Work is stated in the Bid Data Form.

10. GRATUITIES AND KICKBACKS.

City Code states that it is unethical for any person to offer, give, or agree to give any City employee or former City employee, or for any City employee or former City employee to solicit, demand, accept, or agree to accept from another person, a gratuity or an offer of employment in connection with any decision, approval, disapproval, recommendation, or preparation of any part of a program requirement or a purchase request, influencing the content of any specification or procurement standard, rendering of advice, investigation, auditing, or in any other advisory capacity in any proceeding or application, request for ruling, determination, claim or controversy, or other particular matter, pertaining to any program requirement or a contract or subcontract, or to any solicitation or proposal therefor. It shall be unethical for any payment, gratuity, or offer of employment to be made by or on behalf of a subcontractor under a contract to the prime contractor or higher tier subcontractor or any person associated therewith, as an inducement for the award of a subcontract or order.

11. FISCAL YEAR.

The City of Grand Island, Nebraska operates on a fiscal year beginning October 1st and ending on the following September 30th. It is understood and agreed that any portion of this agreement which will be performed in a future fiscal year is contingent upon the City Council adopting budget statements and appropriations sufficient to fund such performance.

CONTRACT AGREEMENT

THIS AGREEMENT made and entered into by and between **[SUCCESSFUL BIDDER]**, hereinafter called the Contractor, and the **CITY OF GRAND ISLAND, NEBRASKA**, hereinafter called the City.

WITNESSETH:

THAT, WHEREAS, in accordance with law, the City has caused contract documents to be prepared and an advertisement calling for bids to be published for BOILER INSPECTION AND REPAIR-FALL 2024 OUTAGE; and

WHEREAS, the City, in the manner prescribed by law, has publicly opened, examined, and canvassed the bids submitted, and has determined the aforesaid Contractor to be the lowest responsive and responsible bidder, and has duly awarded to said Contractor a contract therefore, for the sum or sums named in the Contractor's bid, a copy thereof being attached to and made a part of this Contract;

NOW, THEREFORE, in consideration of the compensation to be paid to the Contractor and of the mutual agreements herein contained, the parties have agreed and hereby agree, the City for itself and its successors, and the Contractor for itself, himself/herself, or themselves, and its, his/her, or their successors, as follows:

ARTICLE I. That the following documents shall comprise the Contract, and shall together be referred to as the "Agreement" or the "Contract Documents";

1. This Contract Agreement.
2. City of Grand Island's Specification for this project.
3. **[NAME OF SUCCESSFUL BIDDER]** bid signed and dated **[DATE OF BID]**.

In the event of any conflict between the terms of the Contract Documents, the provisions of the document first listed shall prevail.

ARTICLE II. That the Contractor shall (a) furnish all tools, equipment, superintendence, transportation, and other construction materials, services and facilities; (b) furnish, as agent for the City, all materials, supplies and equipment specified and required to be incorporated in and form a permanent part of the completed work; (c) provide and perform all necessary labor; and (d) in a good substantial and workmanlike manner and in accordance with the requirements, stipulations, provisions, and conditions of the Contract documents as listed in the attached General Specifications, said documents forming the Contract and being as fully a part thereof as if repeated verbatim herein, perform, execute, construct and complete all work included in and covered by the City's official award of this Contract to the said Contractor, such award being based on the acceptance by the City of the Contractor's bid;

ARTICLE III. That the City shall pay to the Contractor for the performance of the work embraced in this Contract and the Contractor will accept as full compensation therefore the sum (subject to adjustment as provided by the Contract) of **[DOLLAR AMOUNT] (\$00.00)** for all services, materials, and work covered by and included in the Contract award and designated in the foregoing Article II; payments thereof to be made in cash or its equivalent in the manner provided in the General Specifications.

The total cost of the Contract includes:

Base Bid:	\$.00
Sales Tax on Materials/Equipment:	\$.00
Sales Tax on Labor:	<u>\$.00</u>
Total	\$.00

The City of Grand Island, Nebraska operates on a fiscal year beginning October 1st and ending on the following September 30th. It is understood and agreed that any portion of this agreement which will be performed in a future fiscal year is contingent upon the City Council adopting budget statements and appropriations sufficient to fund such performance.

ARTICLE IV. The Contractor hereby agrees to act as agent for the City in purchasing materials and supplies for the City for this project. The City shall be obligated to the vendor of the materials and supplies for the purchase price, but the Contractor shall handle all payments hereunder on behalf of the City. The vendor shall make demand or claim for payment of the purchase price from the City by submitting an invoice to the Contractor. Title to all materials and supplies purchased hereunder shall vest in the City directly from the vendor. Regardless of the method of payment, title shall vest immediately in the City. The Contractor shall not acquire title to any materials and supplies incorporated into the project. All invoices shall bear the Contractor's name as agent for the City. This paragraph will apply only to these materials and supplies actually incorporated into and becoming a part of the finished product of the BOILER INSPECTION AND REPAIR-FALL 2024 OUTAGE.

ARTICLE V. That the Contractor shall start work as soon as possible after the Contract is signed and the required bonds and insurance are approved, and that the Contractor shall deliver the equipment, tools, supplies, and materials F.O.B. Platte Generating Station, and complete the work on or before the end of the scheduled spring outage, currently scheduled for September 26, 2024 to October 12, 2024.

ARTICLE VI. The Contractor agrees to comply with all applicable State fair labor standards in the execution of this Contract as required by Section 73-102, R.R.S. 1943. The Contractor further agrees to comply with the provisions of Section 48-657, R.R.S. 1943, pertaining to contributions to the Unemployment Compensation Fund of the State of Nebraska. During the performance of this Contract, the Contractor and all subcontractors agree not to discriminate in hiring or any other employment practice on the basis, of race, color, religion, sex, national origin, age or disability. The Contractor agrees to comply with all applicable Local, State and Federal rules and regulations. The Contractor agrees to maintain a drug-free workplace policy and will provide a copy of the policy to the City upon request. Every public contractor and his, her or its subcontractors who are awarded a contract by the City for the physical performance of services within the State of Nebraska shall register with and use a federal immigration verification system to determine the work eligibility status of new employees physically performing services within the State of Nebraska.

ARTICLE VII. Gratuities and kickbacks: City Code states that it is unethical for any person to offer, give, or agree to give any City employee or former City employee, or for any City employee or former City employee to solicit, demand, accept, or agree to accept from another person, a gratuity or an offer of employment in connection with any decision, approval, disapproval, recommendation, or preparation of any part of a program requirement or a purchase request, influencing the content of any specification or procurement standard, rendering of advice, investigation, auditing, or in any other advisory capacity in any proceeding or application, request for ruling, determination, claim or controversy, or other particular matter, pertaining to any program requirement or a contract or subcontract, or to any solicitation or proposal therefor. It

shall be unethical for any payment, gratuity, or offer of employment to be made by or on behalf of a subcontractor under a contract to the prime contractor or higher tier subcontractor or any person associated therewith, as an inducement for the award of a subcontract or order.

[SUCCESSFUL BIDDER]

By _____ Date _____

Title _____

CITY OF GRAND ISLAND, NEBRASKA

By _____ Date _____
Mayor

Attest: _____
City Clerk

The Contract is in due form according to law and hereby approved.

Attorney for the City

Date

DRAFT

MINIMUM INSURANCE REQUIREMENTS
CITY OF GRAND ISLAND, NEBRASKA

The successful bidder shall obtain insurance from companies authorized to do business in Nebraska of such types and in such amounts as may be necessary to protect the Bidder and the interests of the City against hazards or risks of loss as hereinafter specified. This insurance shall cover all aspects of the Bidder's operations and completed operations. Failure to maintain adequate coverage shall not relieve Bidder of any contractual responsibility or obligation. Minimum insurance coverage shall be the amounts stated herein or the amounts required by applicable law, whichever are greater.

1. WORKERS COMPENSATION AND EMPLOYER'S LIABILITY

This insurance shall protect the Bidder against all claims under applicable State workers compensation laws. This insurance shall provide coverage in every state in which work for this project might be conducted. The liability limits shall not be less than the following:

Workers Compensation	Statutory Limits
Employers Liability	\$100,000 each accident
	\$100,000 each employee
	\$500,000 policy limit

2. BUSINESS AUTOMOBILE LIABILITY

This insurance shall be written in comprehensive form and shall protect the Bidder, Bidder's employees, or subcontractors from claims due to the ownership, maintenance, or use of a motor vehicle. The liability limits shall not be less than the following:

Bodily Injury & Property Damage	\$ 500,000 Combined Single Limit
---------------------------------	----------------------------------

3. COMPREHENSIVE GENERAL LIABILITY

The comprehensive general liability coverage shall contain no exclusion relative to explosion, collapse, or underground property. The liability limits shall not be less than the following:

Bodily Injury & Property Damage	\$ 500,000 each occurrence
	\$1,000,000 aggregate

4. UMBRELLA LIABILITY INSURANCE

This insurance shall protect the Bidder against claims in excess of the limits provided under employer's liability, comprehensive automobile liability, and commercial general liability policies. The umbrella policy shall follow the form of the primary insurance, including the application of the primary limits. The liability limits shall not be less than the following:

Bodily Injury & Property Damage	\$1,000,000 each occurrence
	\$1,000,000 general aggregate

5. ADDITIONAL REQUIREMENTS

The City may require insurance covering a Bidder or subcontractor more or less than the standard requirements set forth herein depending upon the character and extent of the work to be performed by such Bidder or subcontractor.

Insurance as herein required shall be maintained in force until the City releases the Bidder of all obligations under the Contract.

The Bidder shall provide and carry any additional insurance as may be required by special provisions of these specifications.

6. CERTIFICATE OF INSURANCE

Satisfactory certificates of insurance shall be filed with the City prior to starting any work on this Contract. **The certificates shall show the City as an additional insured on all coverage except Workers Compensation. The certificate shall state that thirty (30) days written notice shall be given to the City before any policy is cancelled (strike the "endeavor to" wording often shown on certificate forms). If the Bidder cannot have the "endeavor to" language stricken, the Bidder may elect to provide a new certificate of insurance every thirty (30) days during the contract. Bidder shall immediately notify the City if there is any reduction of coverage because of revised limits or claims paid which affect the aggregate of any policy.**

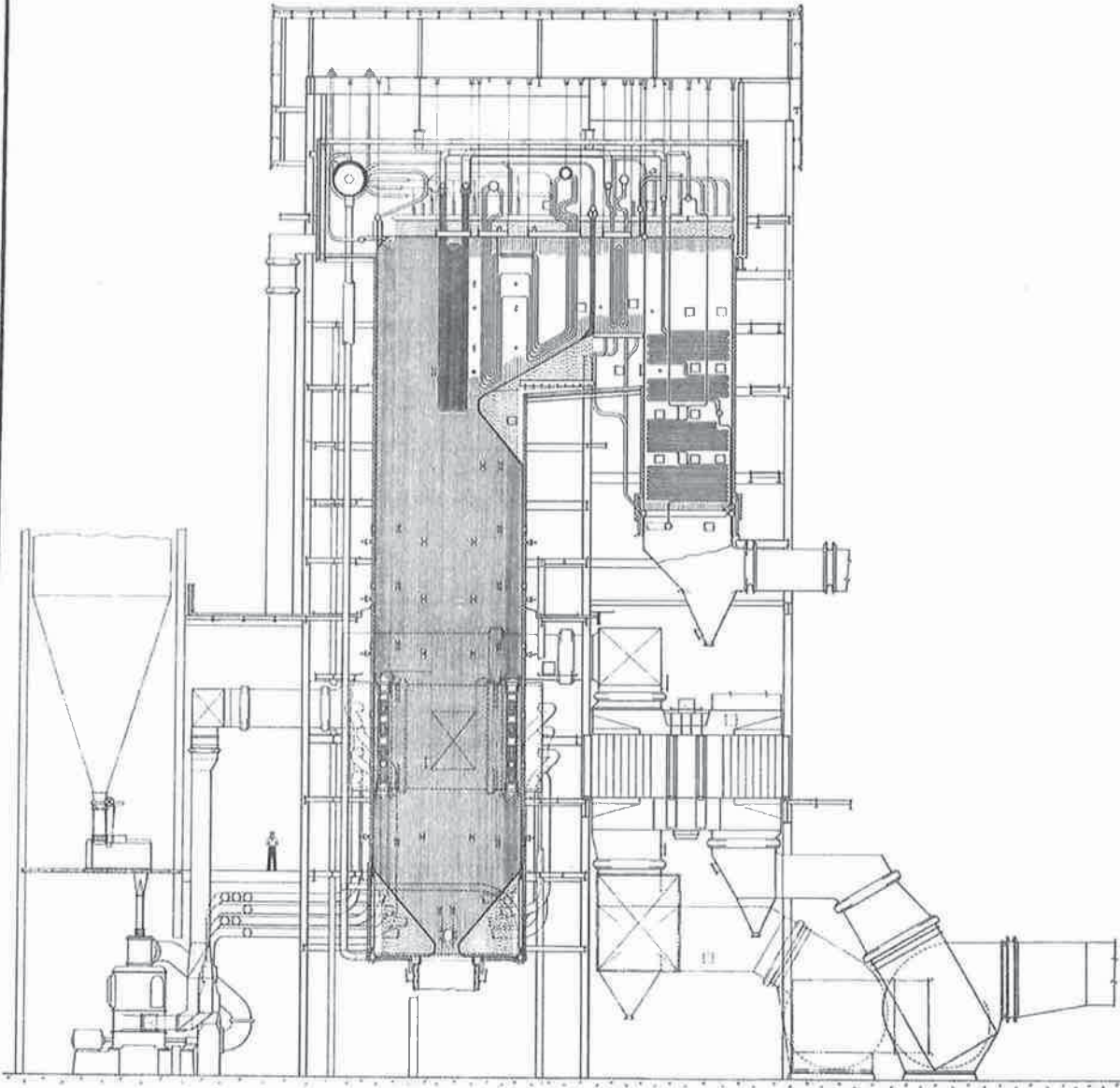

Dwg. No. 40-195

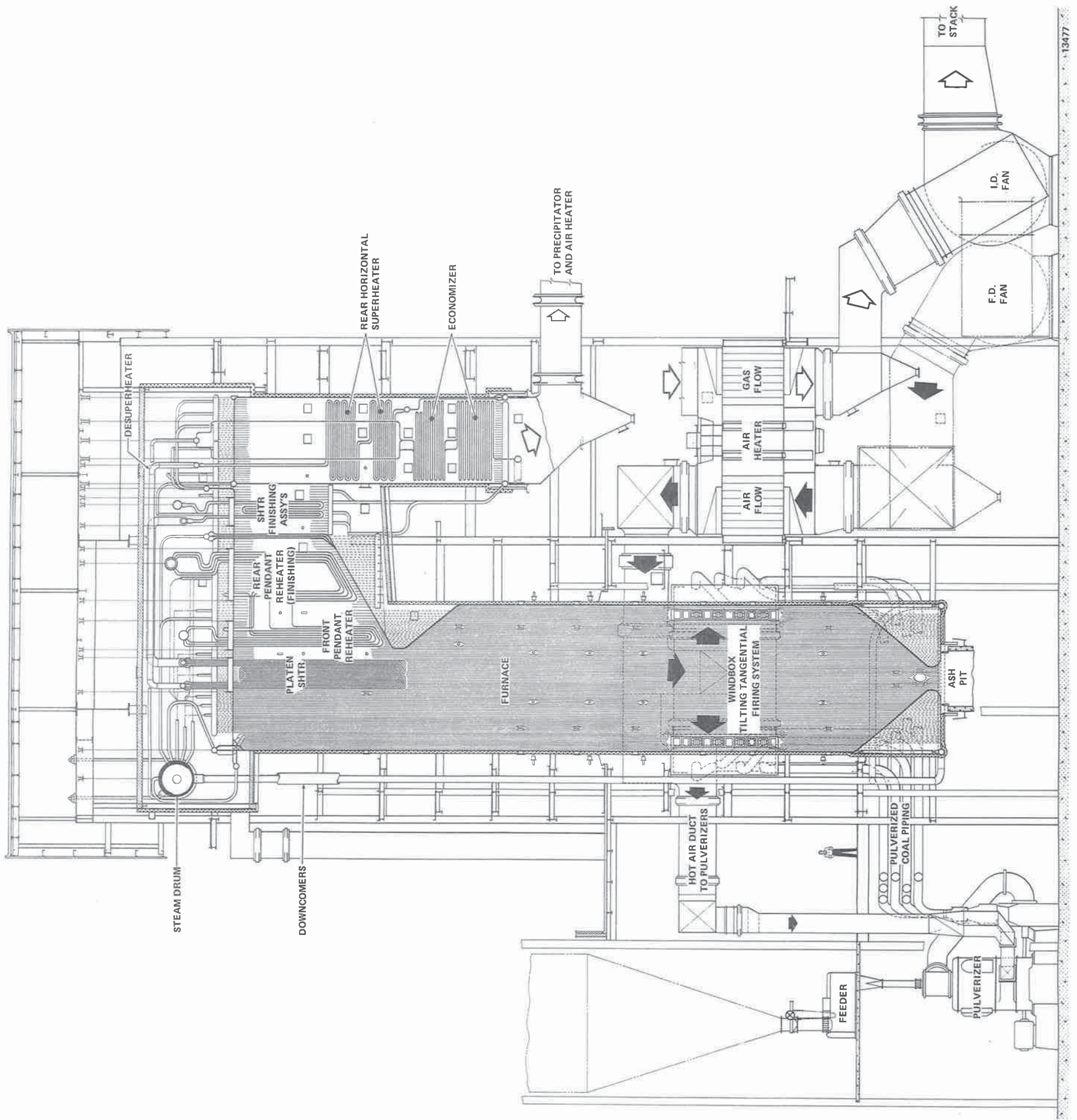

GENERAL ARRANGEMENT
FIGURE 1

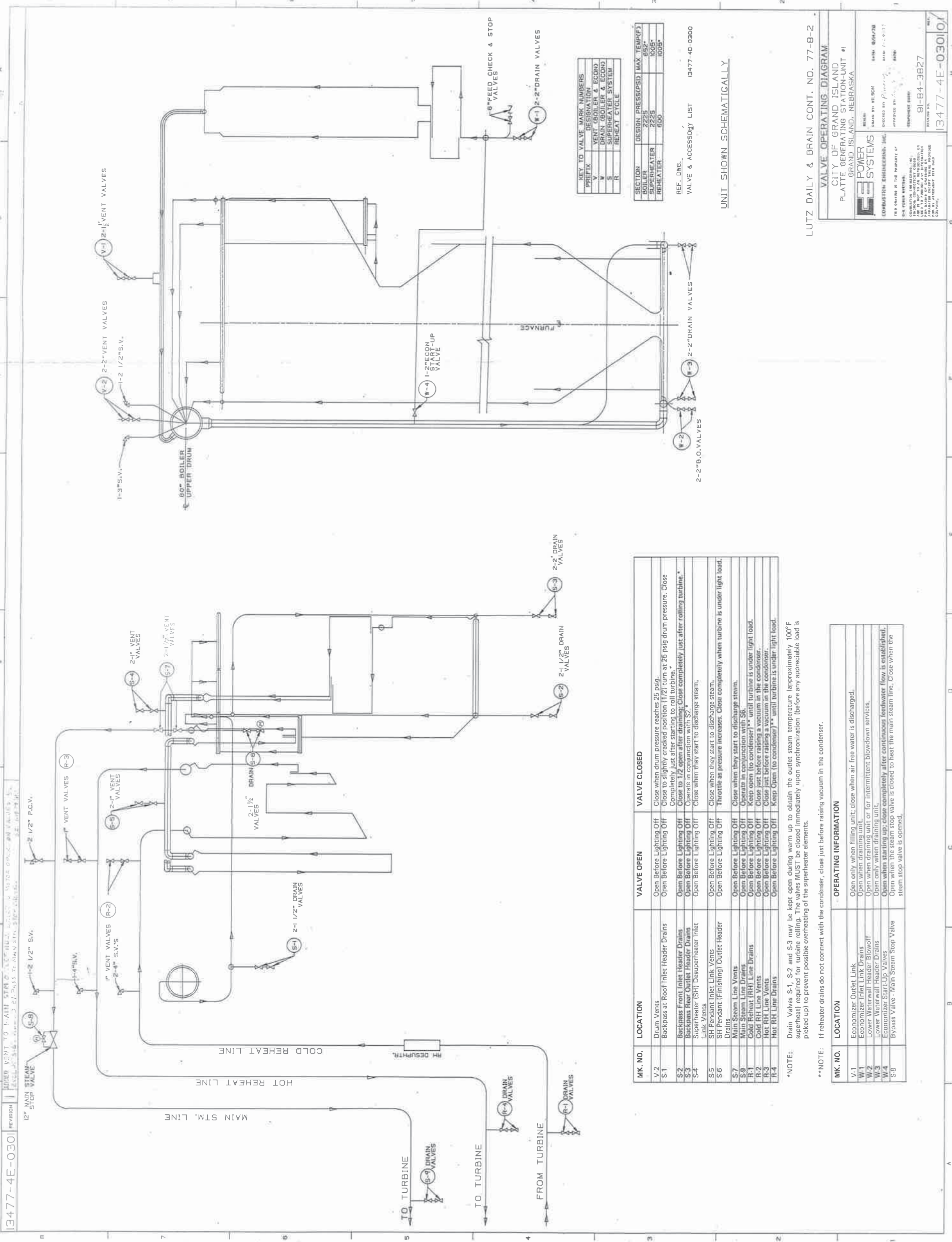

KEY TO VALVE MARK NUMBERS

PREFIX	DESIGNATION
V	VENT (BOILER & ECON)
W	DRAIN (BOILER & ECON)
S	SUPERHEATER SYSTEM
R	REHEAT CYCLE

SECTION	DESIGN PRESS(P.S.I.)	MAX TEMP(F)
BOILER	2225	852*
SUPERHEATER	2225	1005*
REHEATER	900	1005*

REF. Dwg. VALVE & ACCESSORY LIST 13477-4D-0300

UNIT SHOWN SCHEMATICALLY

MK. NO.	LOCATION	VALVE OPEN	VALVE CLOSED
V-2	Drum Vents	Open Before Lighting Off	Close when drum pressure reaches 25 psig.
S-1	Backpass at Roof Inlet Header Drains	Open Before Lighting Off	Close to slightly cracked position (1/2) turn at 25 psig drum pressure. Close completely just after starting to roll turbine.
S-2	Backpass Front Inlet Header Drains	Open Before Lighting Off	Close to 1/2 open after draining. Close completely just after rolling turbine.*
S-3	Backpass Rear Outlet Header Drains	Open Before Lighting Off	Operate in conjunction with S2.*
S-4	Superheater (SH) Desuperheater Inlet Link Vents	Open Before Lighting Off	Close when they start to discharge steam.
S-5	SH Pendant Inlet Link Vents	Open Before Lighting Off	Close when they start to discharge steam.
S-6	SH Pendant (Finishing) Outlet Header Drains	Open Before Lighting Off	Throttle as pressure increases. Close completely when turbine is under light load.
S-7	Main Steam Line Vents	Open Before Lighting Off	Operate in conjunction with S6.
S-9	Cold Reheat (RH) Line Drains	Open Before Lighting Off	Close when they start to discharge steam.
R-1	Cold Reheat (RH) Line Vents	Open Before Lighting Off	Close when turbine is under light load.
R-2	Hot RH Line Vents	Open Before Lighting Off	Close when turbine is under light load.
R-3	Hot RH Line Vents	Open Before Lighting Off	Close when turbine is under light load.
R-4	Hot RH Line Drains	Open Before Lighting Off	Close when turbine is under light load.

*NOTE: Drain Valves S-1, S-2 and S-3 may be kept open during warm up to obtain the outlet steam temperature (approximately 100°F superheat) required for turbine rolling. The valves MUST be closed immediately upon synchronization (before any appreciable load is picked up) to prevent possible overheating of the superheater elements.

**NOTE: If reheater drains do not connect with the condenser, close just before raising vacuum in the condenser.

MK. NO.	LOCATION	OPERATING INFORMATION
V-1	Economizer Outlet Link	Open only when filling unit; close when air free water is discharged.
W-1	Economizer Inlet Link Drains	Open when draining unit.
W-2	Lower Waterwall Header Blowoff	Open when draining unit or for intermittent blowdown services.
W-3	Lower Waterwall Header Drains	Open only when draining unit.
W-4	Economizer Start-Up Valves	Open when turbine is under light load. Close completely after continuous feedwater flow is established.
S-8	Bypass Valve - Main Steam Stop Valve	Close when the steam stop valve is closed to heat the main steam line. Close when the steam stop valve is opened.

13477-4E-0300

VALVE OPERATING DIAGRAM

CITY OF GRAND ISLAND
PLATTE GENERATING STATION-UNIT #1
GRAND ISLAND, NEBRASKA

POWER SYSTEMS
COMPUTER ENGINEERING, INC.
13477-4E-0300

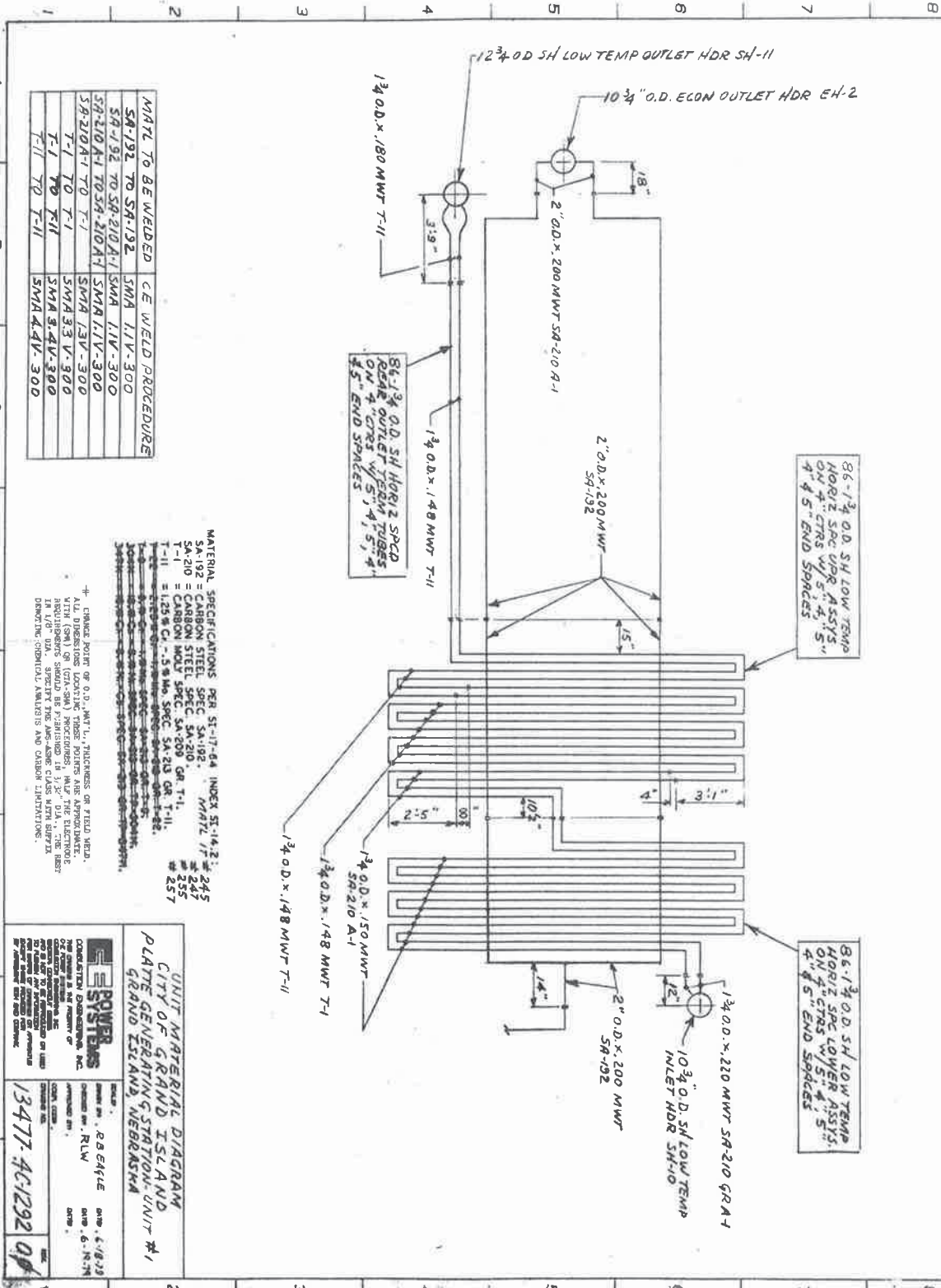

MATERIAL TO BE WELDED CE WELD PROCEDURE

SA-192 TO SA-192	SMA 11V-300
SA-192 TO SA-210 A-1	SMA 11V-300
SA-210 A-1 TO SA-210 A-1	SMA 13V-300
SA-210 A-1 TO T-1	SMA 33V-300
T-1 TO T-1	SMA 33V-300
T-1 TO T-11	SMA 44V-300
T-11 TO T-11	SMA 44V-300

MATERIAL SPECIFICATIONS PER SECTION 17.44 INDEX 51-14.2:

SA-192 = CARBON STEEL, SPEC. SA-192, MATL. # 245
 SA-210 = CARBON STEEL, SPEC. SA-210, GR. T-1, # 247
 T-1 = CARBON MOLT. SPEC. SA-209, GR. T-1, # 255
 T-11 = 1.25% CR., 5% MO, SPEC. SA-213, GR. T-11, # 257

ALL DIMENSIONS LOCATING THOSE POINTS ARE APPROXIMATE.
 WITH (SM) OR (CM) PROCEDURES AND THE ELECTRODE
 IN 1/8" DIA. SPECIFY THE APPROPRIATE CLASS WITH SURFACE
 DENTING, CHEMICAL ANALYSIS AND CARBON LIMITATIONS.

UNIT MATERIAL DIAGRAM
 CITY OF GRAND ISLAND
 PLATE GENERATING STATION-UNIT #1
 GRAND ISLAND, NEBRASKA

DESIGNED BY: RB EATLE
 CHECKED BY: RLW
 DATE: 4/8/12
 DATE: 6/18/12

CONSTRUCTION DOCUMENTS INC.
 13477-4C-1292

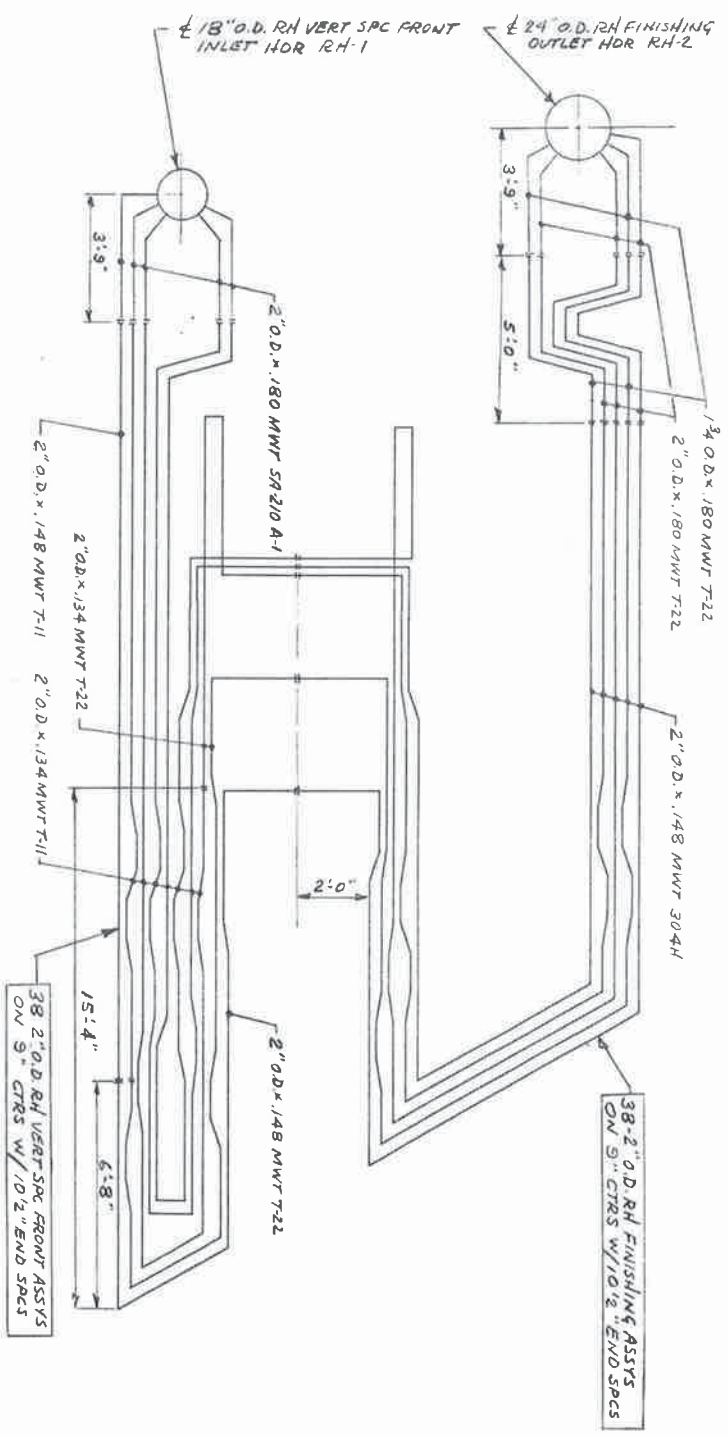

MATL TO BE WELDED CE WELD PROCEDURE

SA-210 TO SA-210	SMA 11V - 300
SA-210 TO T-11	SMA 14V - 300
T-11 TO T-11	SMA 44V - 300
T-11 TO T-22	SMA 45V - 300
T-22 TO T-22	SMA 55V - 300
T-11 TO 304H	SMA 48V - 300
T-22 TO 304H	SMA 58V - 300
304H TO 304H	SMA 88V - 300

MATERIAL SPECIFICATIONS PER SA-11-84 INDEX SA-14.2:
 SA-210 - CARBON STEEL SPEC SA-210, A1772 1/2" # 247
 T-11 - CARBON-STEEL SPEC SA-210, A1772 1/2" # 247
 T-22 - CARBON-STEEL SPEC SA-210, A1772 1/2" # 247
 T-11 - 1.25% CR - 5% Ni SPEC SA-213 OR T-11, # 257
 T-22 - 2.25% CR - 1% Ni SPEC SA-213 OR T-22, # 258
 304H - 18% CR - 8% Ni SPEC SA-213 OR TP-304H, # 266
 304H - 18% CR - 8% Ni SPEC SA-213 OR TP-304H, # 266

± CHANGED POINT OF O.D. MWT L., THICKNESS OR FIELD VELD.
 ALL DIMENSIONS LOCATING THREE POINTS ARE APPROXIMATE.
 FIELD POINTS SHOULD BE FINISHED IN 1/2" DIA., THE BEST
 18 1/8" DIA. SPECIFY THE ASS-ASHE CLASS WITH E277X
 DRAWING: CHEMICAL ANALYSIS AND CARBON LIMITATIONS.

CE POWER SYSTEMS
 CONSULTING ENGINEERS, INC.
 13477-4C-1291 00

UNIT MATERIAL DIAGRAM
 CITY OF GRAND ISLAND
 PLATE GENERATING STATION-UNIT #1
 GRAND ISLAND, NEBRASKA

SCALE: DRAWN BY: R.B. ENFITE DATE: 6-18-78
 CHECKED BY: RLW DATE:
 APPROVED BY: DATE:
 COMMENTS:

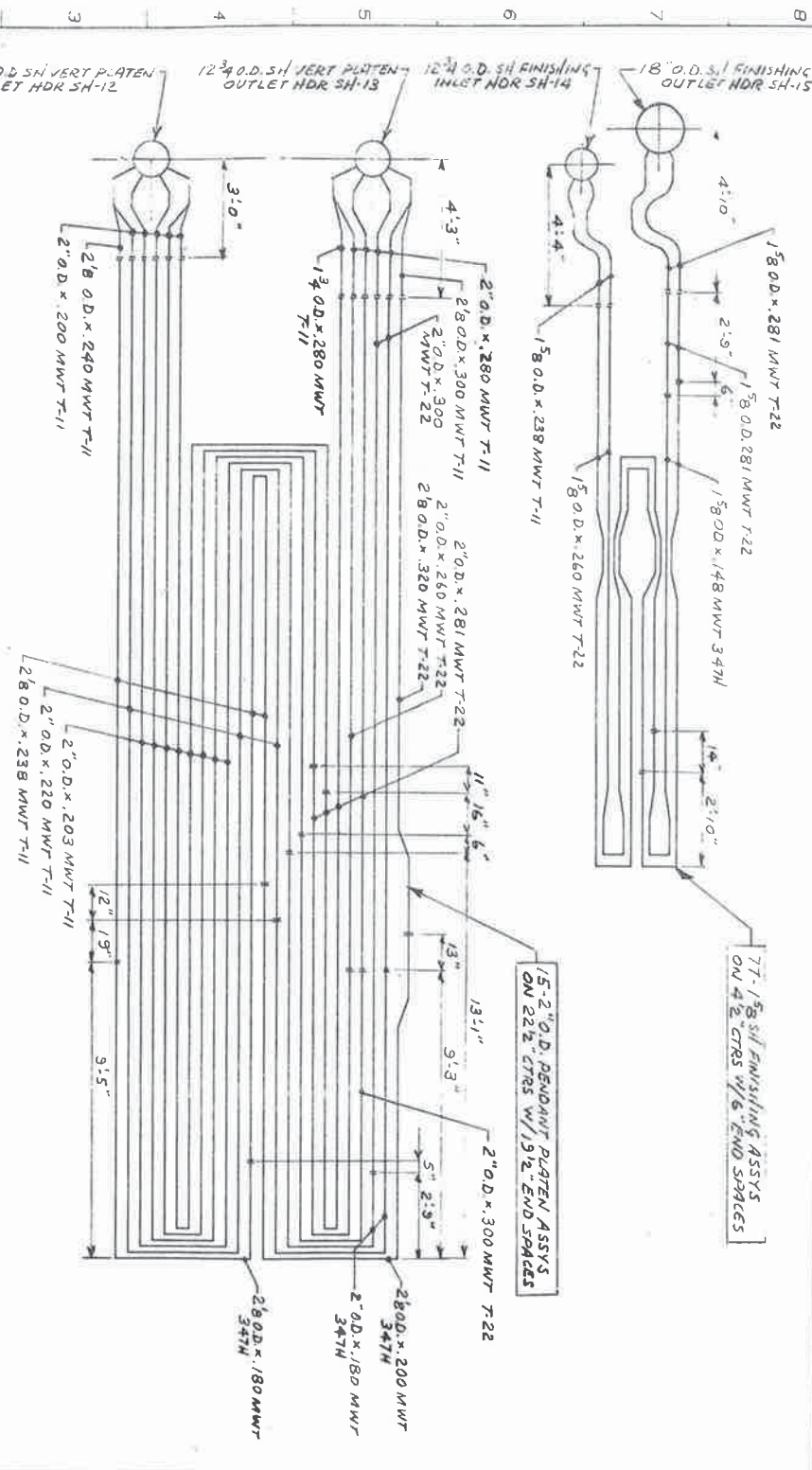

MAT'L TO BE WELDED C/E WELD PROCEDURE

TO	FROM	C/E	WELD PROCEDURE
T-11	T-11	SMA A4V-300	
T-11	T-22	SMA A4V-300	
T-22	T-22	SMA 5.5V-300	
T-11	T-22	SMA 5.5V-300	
T-22	347H	SMA 4.8V-300	
T-22	347H	SMA 5.8V-300	
347H	347H	SMA 8.8V-301	

UNIT MATERIAL DIAGRAM

CITY OF GRAND ISLAND PLATE GENERATING STATION- UNIT #1

GRAND ISLAND, NEBRASKA

POWER SYSTEMS

DESIGNED BY: RBC/c/ce

DATE: 6-18-79

CHECKED BY: R/W

DATE: 4-18-79

13477-4C-1290

MATERIAL SPECIFICATIONS PER SI-17-64 INDEX SI-14.2:

SH-12 = 12 3/4" O.D. x 3.375" THICK

SH-13 = 12 3/4" O.D. x 3.375" THICK

SH-14 = 12 3/4" O.D. x 3.375" THICK

SH-15 = 18" O.D. x 3.375" THICK

T-11 = 2" O.D. x 3.375" THICK

T-22 = 2" O.D. x 3.375" THICK

347H = 2 5/8" O.D. x 3.375" THICK

± CHANGE POINT OR O.D. ± W.T.L. ± THICKNESS OR FIELD YIELD.

ALL DIMENSIONS LOCATING PLATE JOINTS ARE APPROXIMATE.

NOTE: (1) PLATE JOINTS TO BE WELDED PER THE WELD PROCEDURE.

(2) 1/8" DIA. SPACERS TO BE PROVIDED IN 2'-0" O.C. THE BEST METHOD TO BE DETERMINED BY THE FABRICATOR.

(3) 1/8" DIA. SPACERS TO BE PROVIDED IN 2'-0" O.C. THE BEST METHOD TO BE DETERMINED BY THE FABRICATOR.

(4) REFER TO THE FABRICATOR'S DRAWING FOR ALL DIMENSIONS.

347H = 16.5" C - 8.5" N - 6.5" Cb. SPEC. SA-213 GR. TP-347H.

268

	Detailed Piping, this Contract
	Field Routed Piping, this Contract
	Piping Furnished and Installed by Others
	Detailed Temporary Piping, this Contract
	Field Routed Temporary Piping, this Contract
	Existing Piping
	Future Piping
	Flexible Hose
	Globe Valve
	Gate Valve
	Angle Valve
	Angle Relief Valve
	In-Line Relief Valve
	Ball Valve
	Plug Valve
	Check Valve
	Angle Stop-Check Valve
	Butterfly Valve
	Three Way Valve
	Four Way Valve
	Locked Open Valve
	Locked Closed Valve
	Service Air Hose Connection
	Service Water Hose Connection
	Fire Hose and Rack
	Two Way Solenoid Operated Valve
	Three Way Solenoid Operated Valve
	Four Way Solenoid Operated Valve
	Motor Operated Valve
	Diaphragm Operated Valve
	Cylinder Operated Valve

	Deluge Valve
	Air Operated Check Valve
	Air Release Valve
	Y-Type Strainer
	T-Type Strainer
	Cone Type Strainer
	Duplex Strainer
	Trap
	Fire Hydrant
	Shower Head
	Expansion Joint
	Union
	Screwed Cap
	Welding Cap
	Blind Flange
	Drip Pan Elbow
	Muffler
	Equipment Drain
	Rain Hood
	Roof Drain
	Pressure Gauge
	Thermometer
	Thermocouple
	Thermometer Test Well
	Resistance Temperature Detector
	Flow Nozzle
	Flow Meter
	Orifice
	Open Sight Flow

	Closed Sight Flow
	Filter
	Pressure Regulator
	Filter Regulator
	Damper Drive
	Drinking Fountain
	Water Closet
	Urinal
	Service Sink
	Lavatory Sink
	Water Heater
	Manhole
	Heat Tracing
	Gauge Glass
	"N" Furnished and Installed by Others
	"LC" Limit of Contract
	"OC" Furnished by Others and Installed by This Contractor
	"PC" Furnished and Installed by This Contract
	ST-I Line Number--See Specification Sheet for Identification
	ODT Connection Designation
	701 Specification Item Designation
	(LS-21) Device List Designation
	Walls
	Floors and Roofs
	Hub Drain

	PT Pressure Transmitter
	PDT Pressure Differential Transmitter
	PS Pressure Switch
	PDS Pressure Differential Switch
	PC Pressure Controller
	PDC Pressure Differential Controller
	TT Temperature Transmitter
	TS Temperature Switch
	TPC Temperature Controller
	LT Level Transmitter
	LS Level Switch
	LI Level Indicator
	LC Level Controller
	FT Flow Transmitter
	FS Flow Switch
	FC Flow Controller
	FI Flow Indicator
	PH PH Cell
	AT Analyzing Transmitter
	C Conductivity Cell
	B Sight Feed Bubbler
	MOV Motor Operated Valve
	SV Solenoid Valve
	TC Thermocouple
	PG Pressure Gauge
	UH Unit Heater
	TI Temperature Indicator



NOTE
THIS DRAWING CONFORMS TO
CONSTRUCTION RECORDS
DATE 1-4-83

UTILITY SYSTEM IMPROVEMENTS GRAND ISLAND, NEBRASKA	
FLOW DIAGRAM LEGEND	
LUTZ, DAILY & BRAIN CONSULTING ENGINEERS P.O. BOX 718 SHAWNEE MISSION, KANSAS 66201	
DESIGN BY JGS	DRAWING NUMBER 77-8-PI
DRAWN BY ALD	
CHECKED BY TJS	
APPROVED BY [Signature]	

REV.	DESCRIPTION

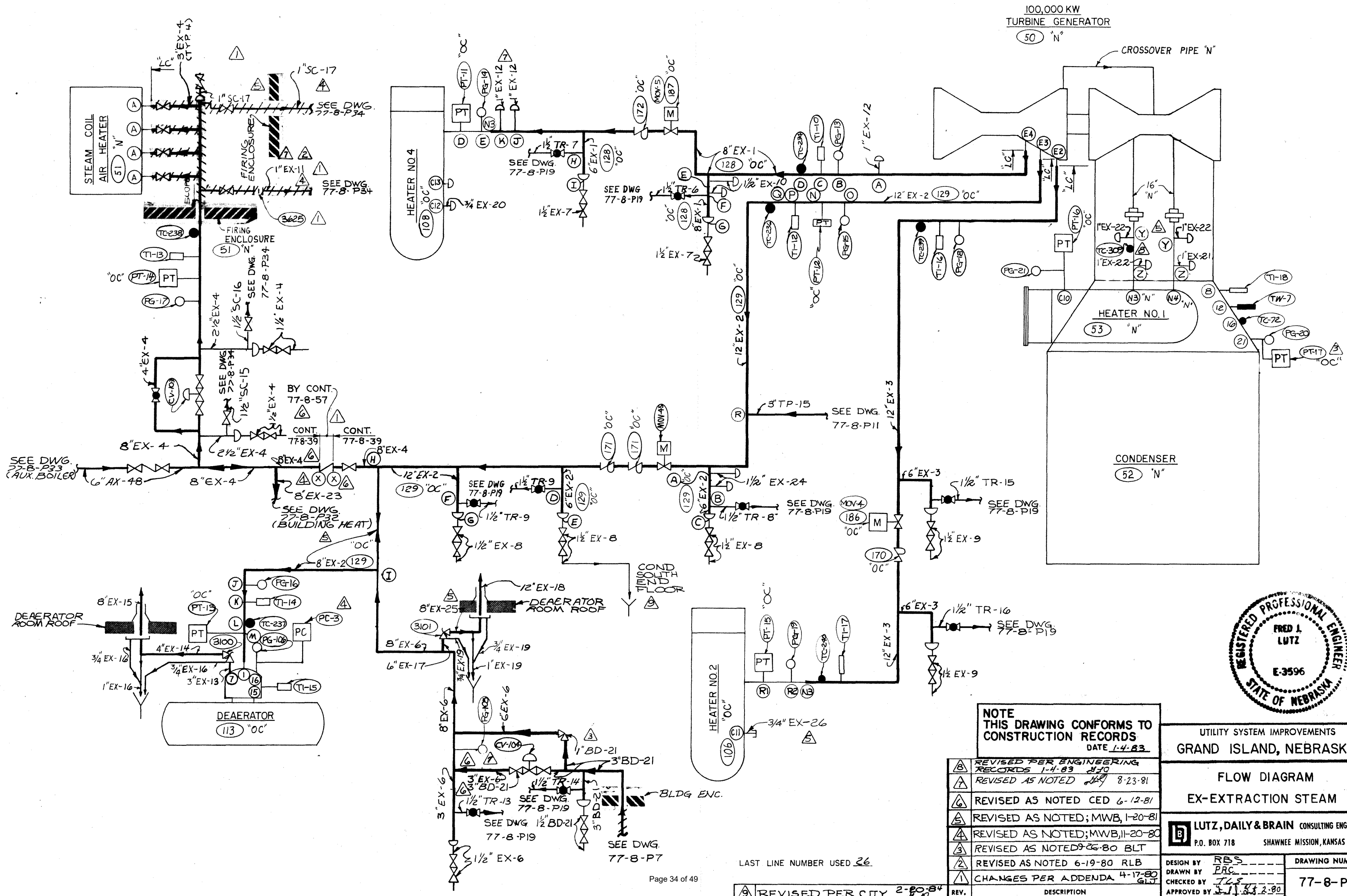

100,000 KW
TURBINE GENERATOR
(50 "N")

CROSSOVER PIPE "N"

HEATER NO. 1
(53 "N")

CONDENSER
(52 "N")

HEATER NO. 4
(108 "OC")

HEATER NO. 2
(106 "OC")

DEAERATOR
(113 "OC")



NOTE
THIS DRAWING CONFORMS TO
CONSTRUCTION RECORDS
DATE 1-4-83

UTILITY SYSTEM IMPROVEMENTS
GRAND ISLAND, NEBRASKA

FLOW DIAGRAM
EX-EXTRACTION STEAM

LUTZ, DAILY & BRAIN CONSULTING ENGINEERS
P.O. BOX 718 SHAWNEE MISSION, KANSAS 66201

REV.	DESCRIPTION
Ⓚ	REVISED PER ENGINEERING RECORDS 1-4-83 JLO
Ⓛ	REVISED AS NOTED 8-23-81
Ⓜ	REVISED AS NOTED CED 6-12-81
Ⓝ	REVISED AS NOTED; MWB, 1-20-81
Ⓟ	REVISED AS NOTED; MWB, 11-20-80
Ⓠ	REVISED AS NOTED 9-26-80 BLT
Ⓡ	REVISED AS NOTED 6-19-80 RLB
Ⓢ	CHANGES PER ADDENDA 4-17-80 GLT
Ⓣ	REVISED PER CITY 2-20-84

DESIGN BY	RBS	DRAWING NUMBER	77-8-P3
DRAWN BY	PRC		
CHECKED BY	JLS		
APPROVED BY	F. J. LUTZ		

LAST LINE NUMBER USED 36

CONDENSER
52 "N"

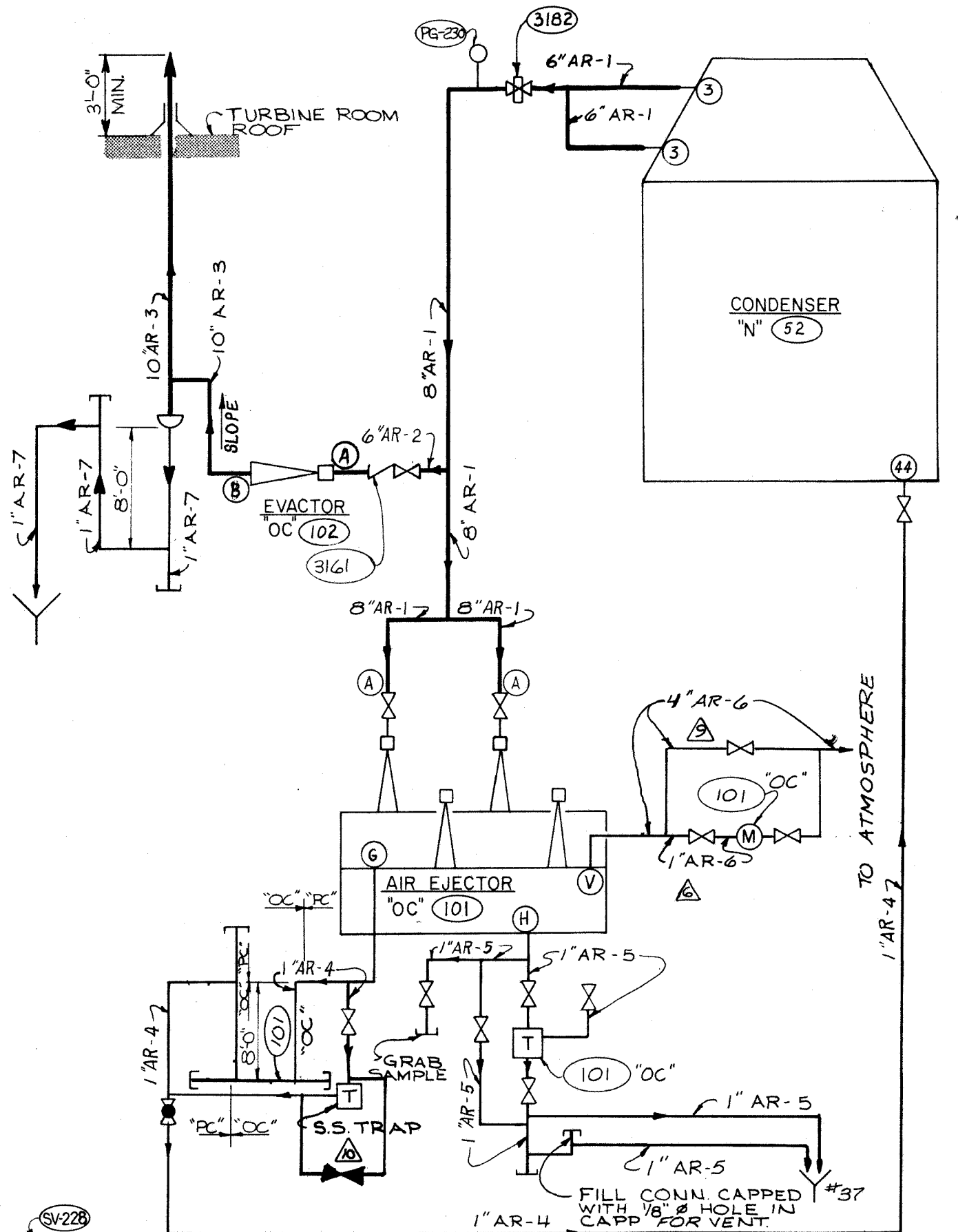
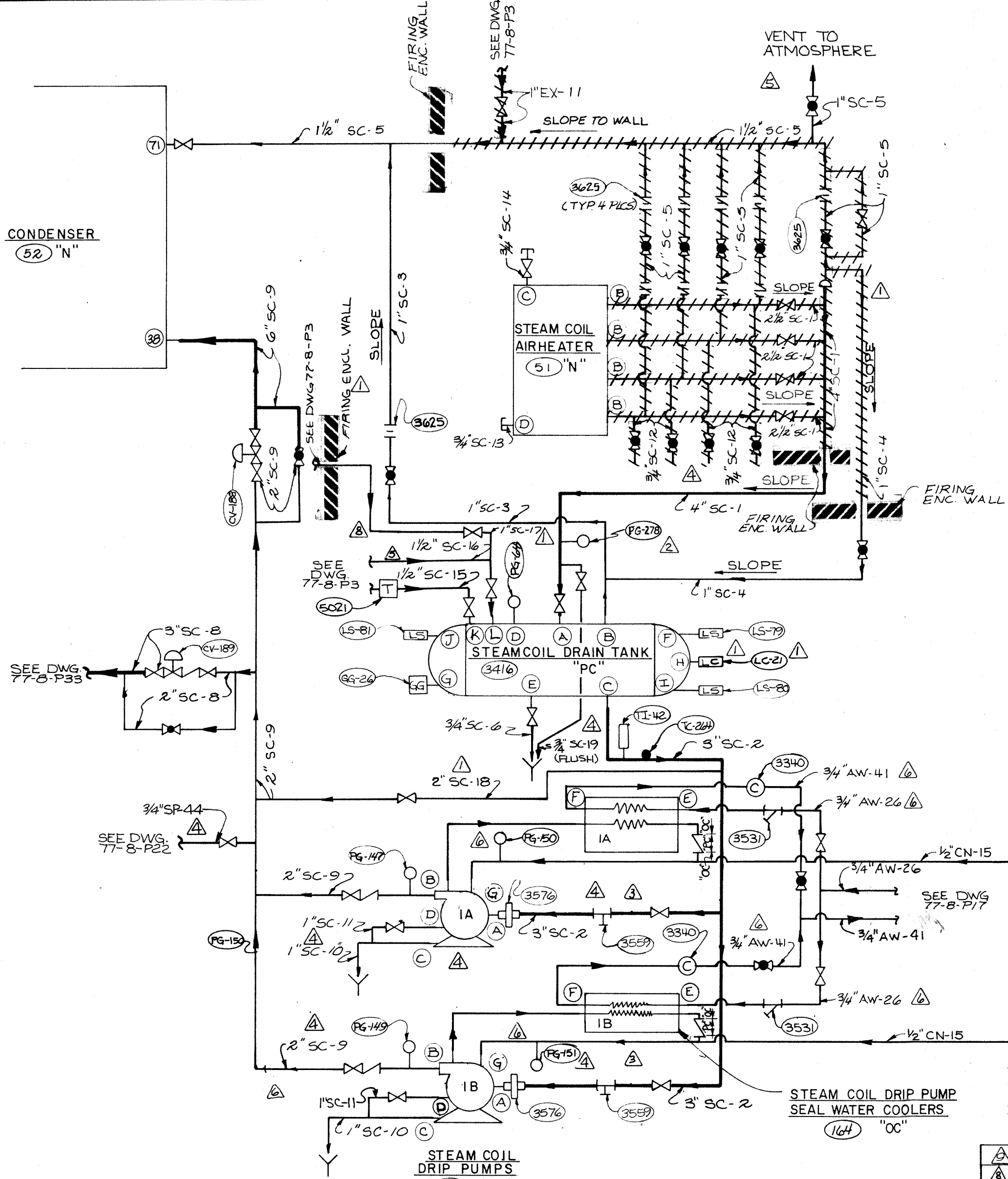

NOTE
THIS DRAWING CONFORMS TO
CONSTRUCTION RECORDS
DATE 1-4-83

REVIS	REVISED PER ENGINEERING RECORDED 1-4-83
REVIS	REVIS
REVIS	REVIS
REVIS	ADDED SEAL WATER LINE & VALVING FOR S.C. DRIP PUMPS CED 8-18-81
REVIS	REVIS
REVIS	REVIS

REVIS	REVISED AS NOTED; MWB, 3-13-81
REVIS	REVISED AS NOTED; MWB, 1-20-81
REVIS	REVISED AS NOTED BAL 7-31-80
REVIS	REVISED AS NOTED 6-26-80 RLB
REVIS	REVISED PER ADDENDA 4-25-80
REVIS	REVISED AS NOTED 4-9 7-27-81

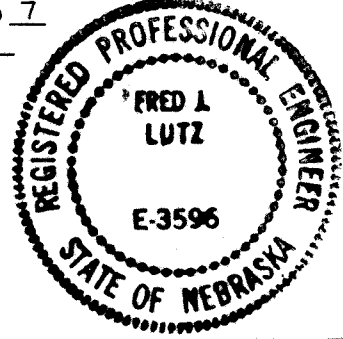

UTILITY SYSTEM IMPROVEMENTS
GRAND ISLAND, NEBRASKA

FLOW DIAGRAM
AR-AIR REMOVAL &
SC-STEAM COIL DRAINS

LUTZ, DAILY & BRAIN CONSULTING ENGINEERS
P.O. BOX 718 SHAWNEE MISSION, KANSAS 66201

DESIGN BY RBS JGS
DRAWN BY JGS
CHECKED BY JGS
APPROVED BY JGS 3-80

DRAWING NUMBER
77-8-P34

LAST LINE NO. USED 19 NO. NOT USED

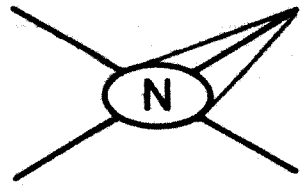

GRAND ISLAND 77-8

NOV 13 1980

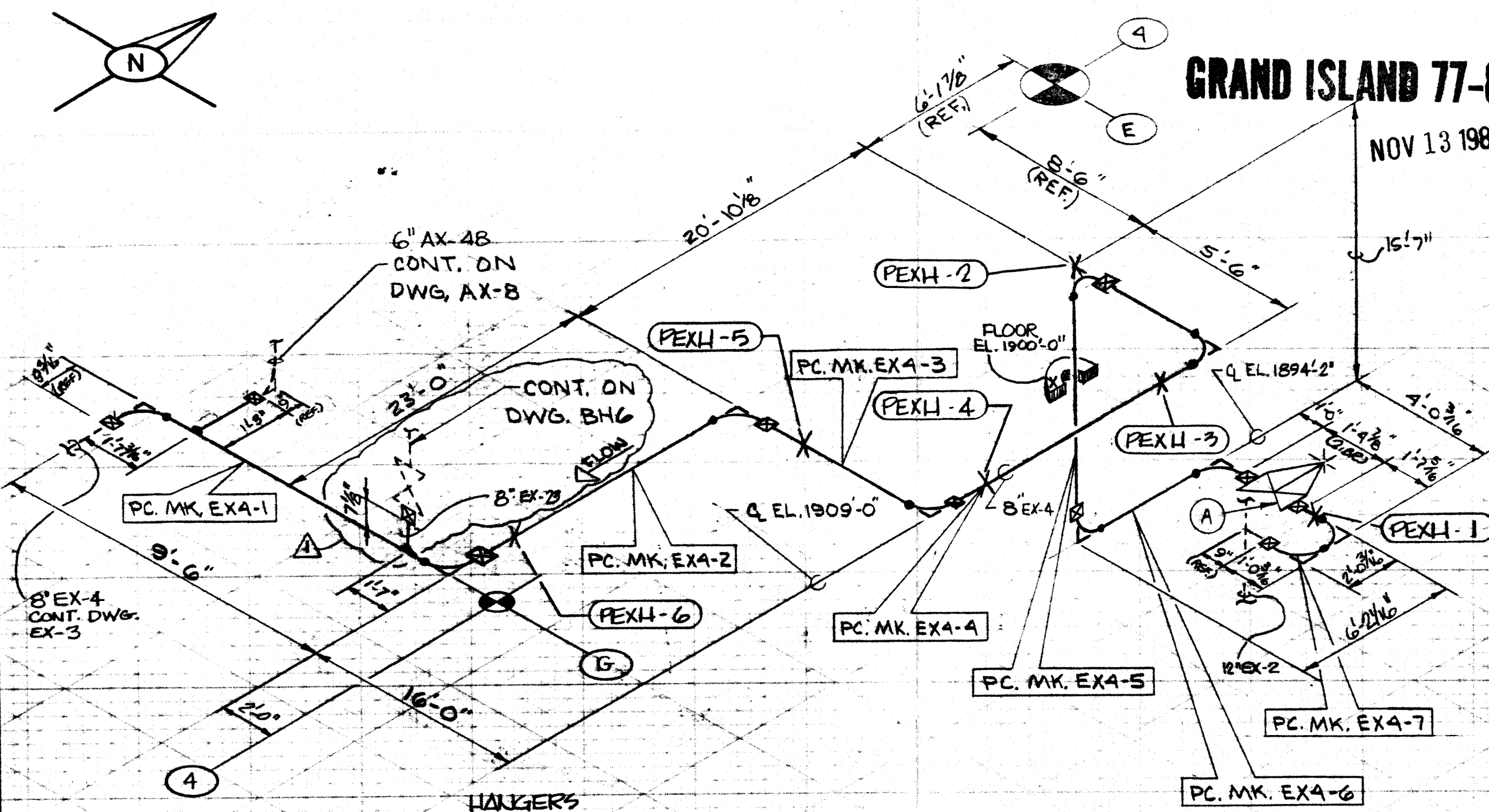

PIPE FOOTAGE
 8" — 104'-0"
 6" — 2'-0"
TOTAL 106'-0"

HANGERS
 PEXH-1
 PEXH-2
 PEXH-3
 PEXH-4
 PEXH-5
 PEXH-6

▲ REVISED PER LD 4B
 ▲ ISO. REVIEW REVD. 10/3/80.

CITY OF GRAND ISLAND
 PLATTE GENERATING STATION
 UNIT #1 CONTRACT #77-8-39

REF. 77-8-Q8 & Q10
 77-8-P3 & P32

MANUFACTURED MATERIAL

ITEM	QTY	SIZE	DESCRIPTION
A	1	8"	150° GATE VA. V-33

FABRICATED MATERIAL

ITEM	QTY	SIZE	DESCRIPTION

- PIPE SPEC. CS/A106-B STD.WT.
 - GASKET SPEC. _____
 - THD. COMP SPEC. NA.
 - _____ ALLOWANCE FOR GASKETS
 - ALLOWANCE FOR WELD GAP 3/16"
 - WELDING PROCEDURE PER JOB SPEC.
- JOB NUMBER 05-9117-1

W.P. - WORKING POINT
 T.O.E. - THREAD ONE END
 T.B.E. - THREAD BOTH ENDS
 B.O.E. - BEVEL ONE END

B.B.E. - BEVEL BOTH ENDS
 P.O.E. - PLAIN ONE END
 P.B.E. - PLAIN BOTH ENDS
 S.O.E. - SHAPE ONE END

H - HORIZONTAL
 V - VERTICAL
 R/L - RANDOM LENGTH
 ◻ - FIELD WELD

○ - AUTOMATIC SHOP WELD
 ● - MANUAL SHOP WELD
 ◻ - VERIFY DIMENSION IN FIELD
 ISSUED: _____

LINE # 8" EX-4 / 6" EX-23
 CODE: _____
 FAB. _____
 ERECT. _____



MECHANICAL CONTRACTORS
 APPLETON, WIS.
 ENGINEERS

DRAWN: DW DATE 10/6/80
 CHECKED: _____ DATE 10/13/80
 APPROVED: L.D. 4B DATE 10/23/80
 DRAWING NUMBER EX-4 REV. 1

300 EX 04

BILL OF MATERIAL (FOR ONE COIL ASS'Y.)	
ITEM REQ'D.	DESCRIPTION
1 4	TYPE HD1-2V5-15-150P-STEAM COIL WITH REMOVABLE CORE, 10 GA. WELDED STL. AIR TIGHT CASINGS, *321 STAIN. STL. 1" O.D. X .049 WALL SEAMLESS OUTER TUBES AND *321 STAIN. STL. 5/8 O.D. X .022 WALL INNER TUBES WITH SOLDER COATED COPPER FINN WITH *304L STAIN. STEEL HEADERS WITH 300 LB. A.N.S.I. FLANGED PIPE CONNECTIONS AND WITH FIT UP HOLES IN CASING FLANGES AS SHOWN

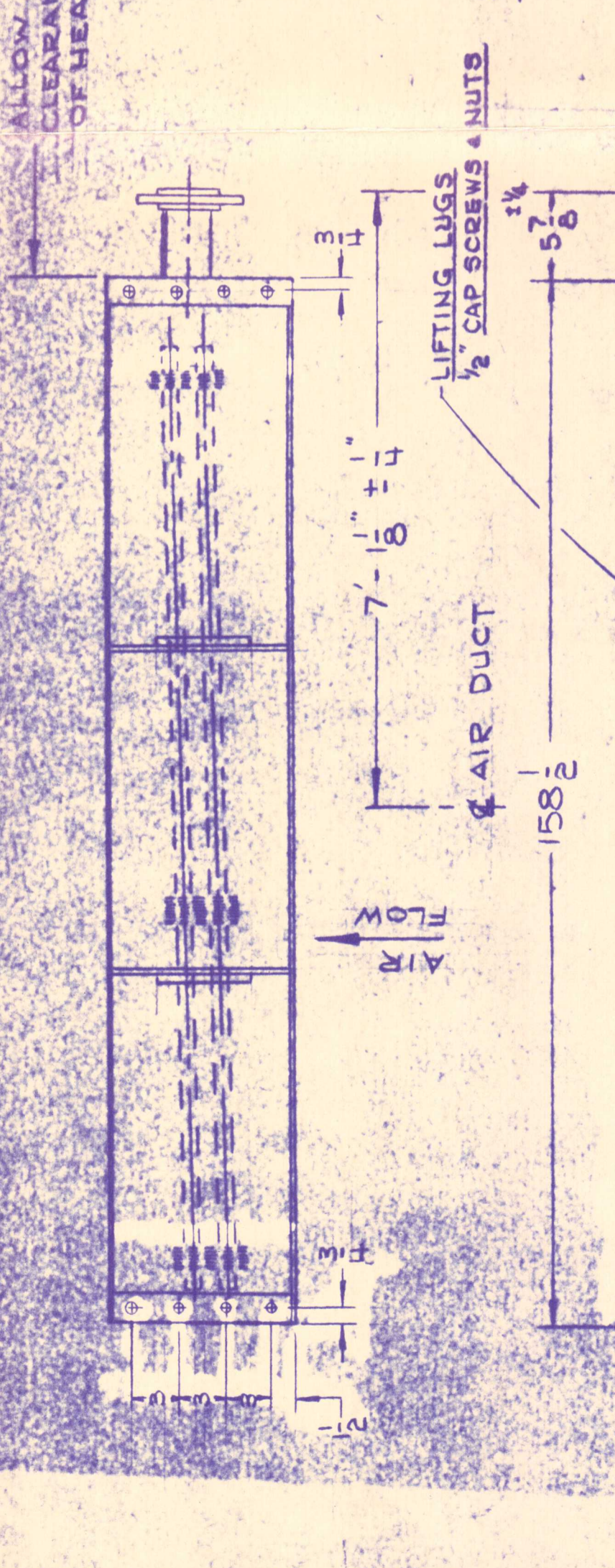
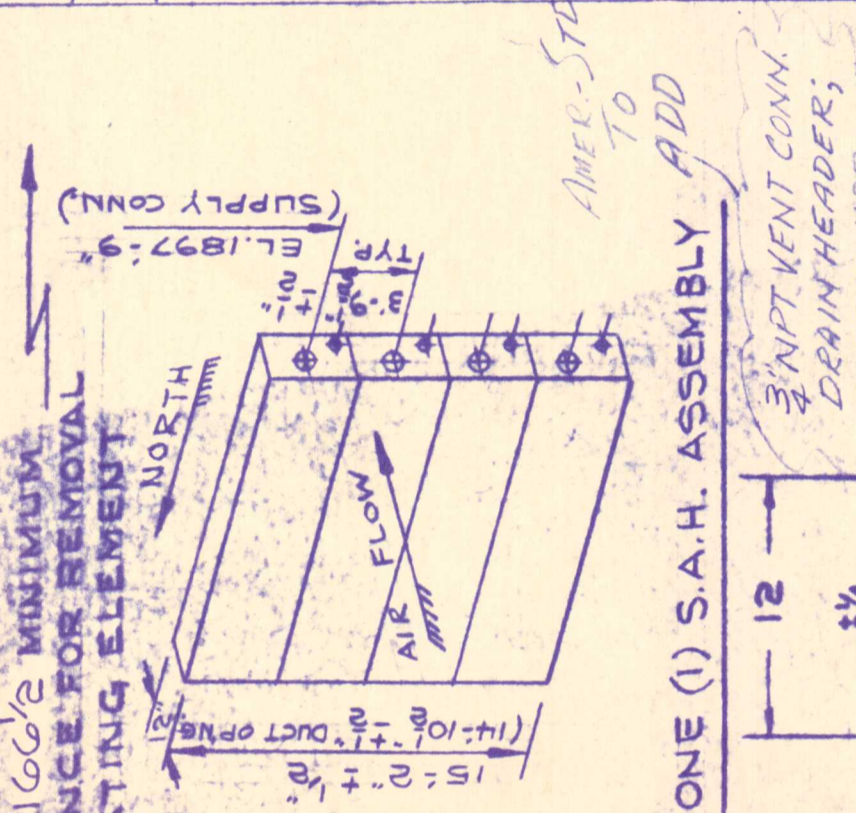

USE: STEAM AIR HEATER

PERFORMANCE EA. HEATER	1	2	3	4
AIR FLOW - M/LBS/HR	1015	786.7	593.3	330
AIR TEMP ENTER - °F	-25	-25	-25	-25
AIR TEMP LEAV - °F	82	107	119	136
DRAFT LOSS H ₂ O	1.0	.72	.48	.2
STEAM - PSIG / TST	64/615	33/598	22/592	3/579
CONDENSATE M ³ /HR	24.9	23.1	18.7	11.25

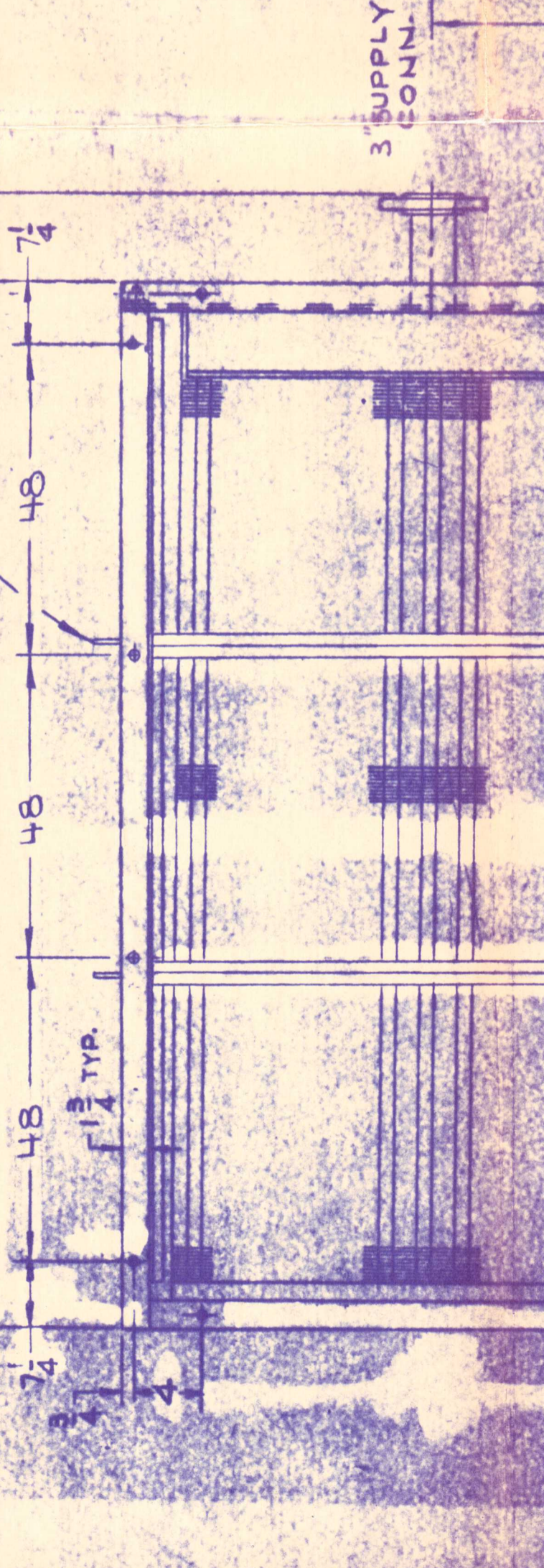
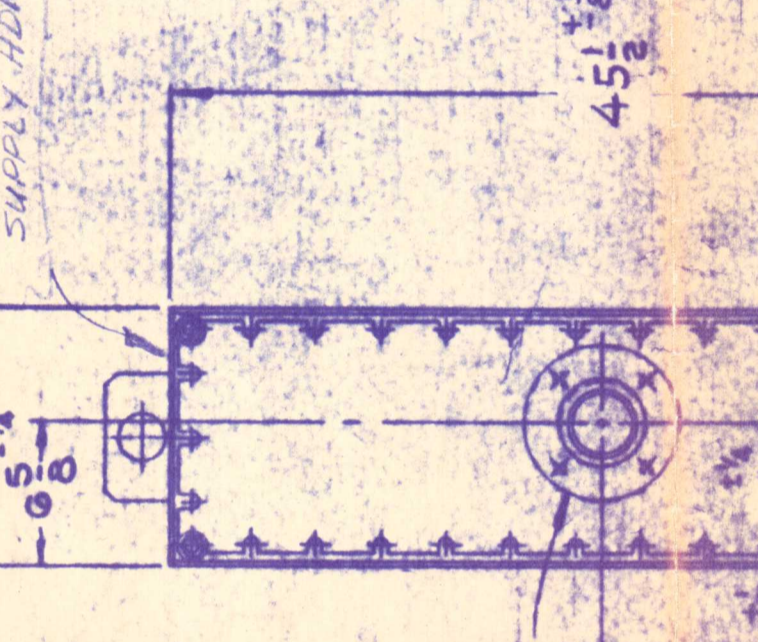

1. GASKET BETWEEN HEADER & CASING PLATES TO BE 1/8" WOVEN ASBESTOS.
 2. HYDROTEST COIL AT 700 PSIG.
 3. AIR TEST UNDER WATER AT 400 P.S.I.G.

SQUARE FEET HEATING SURFACE EACH COIL IS: 14,586 FT²

WEIGHT OF ONE CORE ASSY. APPROX. 1250 LBS
 TOTAL WEIGHT OF STEAM AIR HEATER APPROX. 5,000 LBS

MAX. DESIGN CONDITION - 300 PSIG @ 750 °F

APPROVED BY: RBS
 DATE: 12-4-78
 RECEIVED FOR: RBS

* Approved for Construction with Engineers Plans and Specifications. Approval does not void any part of contract or separate location quantities or dimensions.



REV.	DATE	DESCRIPTION
A	10-9-78	OWG. REVISED PER CUST. MARKED PRINT

REV.	DATE	DESCRIPTION
A	10-9-78	OWG. REVISED PER CUST. MARKED PRINT

REV.	DATE	DESCRIPTION
A	10-9-78	OWG. REVISED PER CUST. MARKED PRINT

SET COILS LEVEL WITHOUT PITCH.

PROVIDE FOR REMOVAL OF CONDENSATE FROM THE STRAM LINE ON THE PRESSURE SIDE OF THE COIL SUPPLY VALVES SO THAT THE LINE CONDENSATE DOES NOT PASS THROUGH COILS.

USE INDIVIDUAL CHECK VALVES IN THE RETURN LINE FROM EACH COIL.

DO NOT BUSH RETURN CONNECTIONS. USE 2" PIPE AND FITTINGS BETWEEN THEIR RETURN CONNECTION AT THE COIL AND THE RETURN MANIFOLD.

PROVIDE A VERTICAL COOLING LEG AT LEAST 12" LONG AT THE RETURN FROM EACH COIL.

PROVIDE FOR CONTINUOUS AIR VENTING BY INSTALLING A PETCOCK AT LEAST 12" ABOVE THE COIL RETURN CONNECTION ON A 1" PIPE RISER FROM THE RETURN LINE OF EACH COIL.

THESE PETCOCKS MUST BE CRACKED OPEN AT ALL TIMES DURING OPERATION.

ALLOW FOR REMOVAL OF THE HEATING ELEMENT BY USING A UNION (OR FLANGED CONNECTIONS) IN THE SUPPLY AND RETURN LINES TO EACH COIL.

PIPING SHOWN FOR ONE COIL BANK. ALL COIL BANKS PIPED IDENTICALLY.

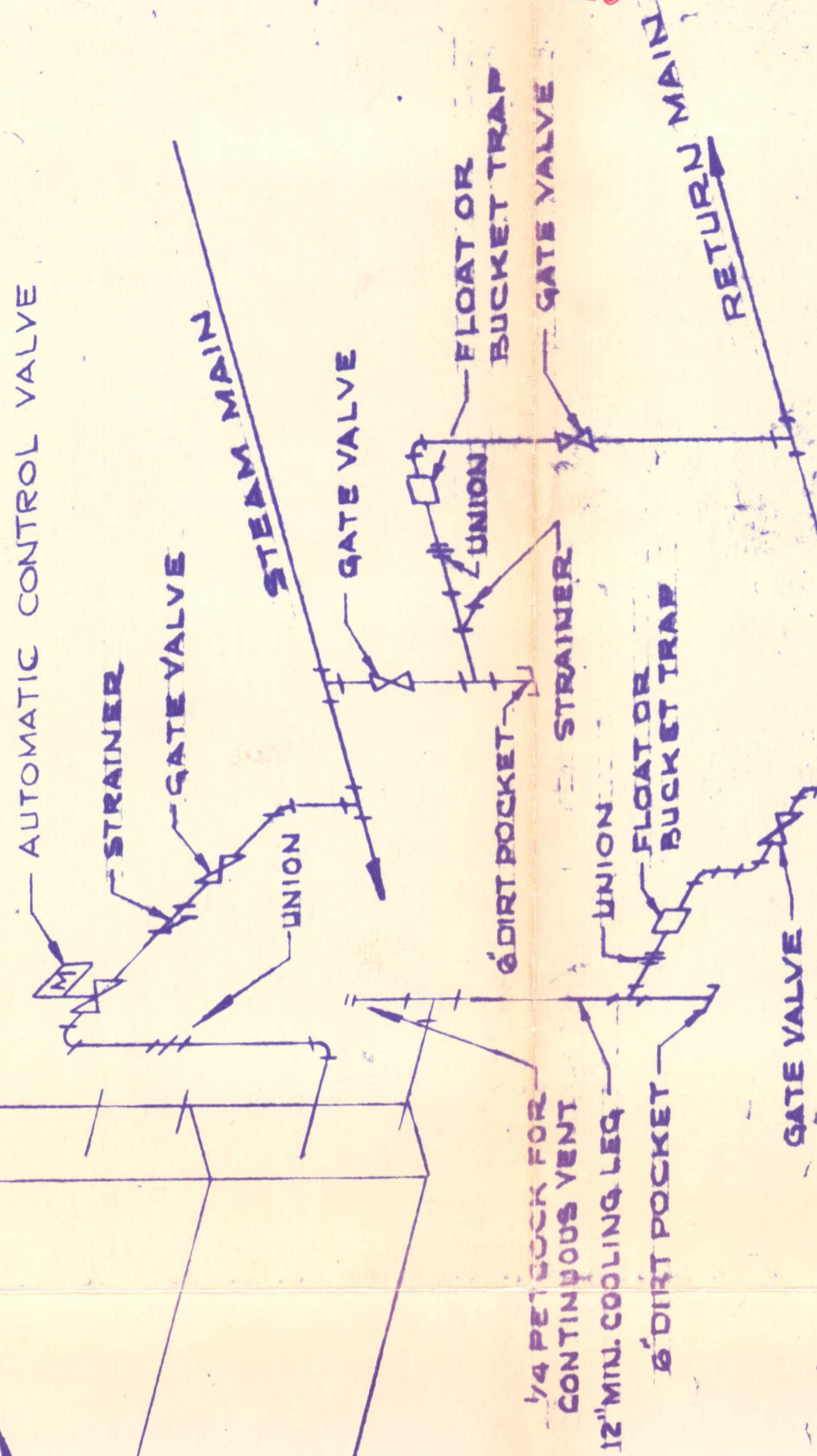
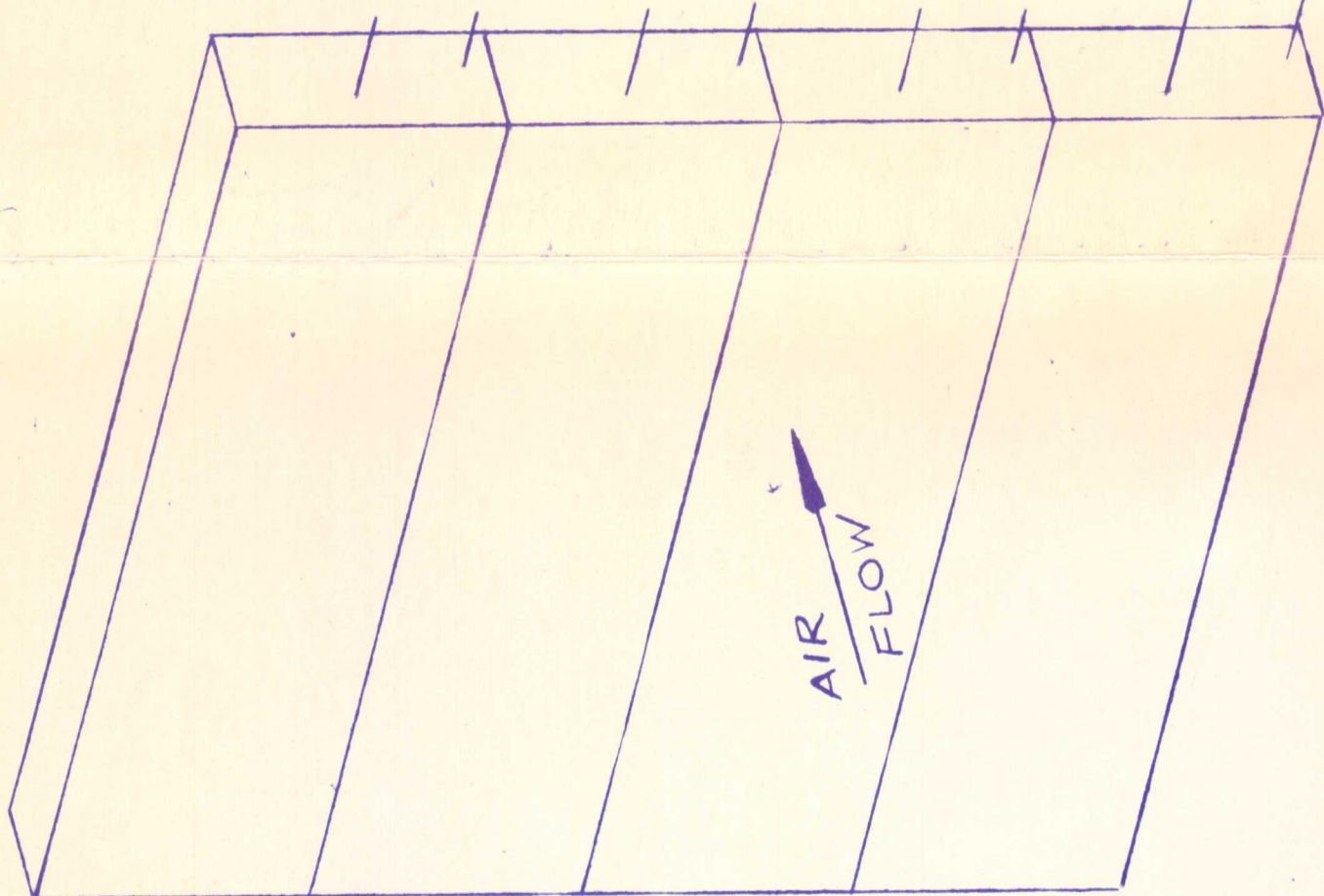

51-257

GRAND ISLAND 77-8

ARRANGEMENT FOR ONE STEAM AIR HEATER

1 - REQ'D.

LUTZ, DAILY & BRAIN
Consulting Engineers
SHAWNEE MISSION, KANSAS

DATE: 12-4-78
BY: RBS

APPROVED AS NOTED
RECORDED FOR CONSTRUCTION

* Approved for Compliance with Engineers Plans and Specifications.
Approval does not void any part-of-contract or guarantee detailed quantities or dimensions.

FOR COIL ASSEMBLY DWG. SEE 83CD4231 NOV 22 1978

FOR B/M SEE DRWG. NO.

REV.	EG-N	ZONE	DESCRIPTION	DATE	CHK.	APPD.
TOLERANCE UNLESS OTHERWISE SPECIFIED			DRAWN N. LUTZ 10-5-78			
0" - 6" = ± 1/64"			CHECKED LMB			
6" - 18" = ± 1/32"			APPD.			
18" - 30" = ± 1/16"			ECN			
30" - 50" = ± 3/32"			SCALE NAME			
50" - 100" = ± 1/8"			MATT. SPEC.			
100" & ABOVE = ± 3/16"			MATT. NO. 187180			
ANGULAR TOLERANCE = ± 1/4°			TITL. SUGGESTED PIPING DIAGRAM			
TOLERANCE TO BE NON-ACCUMULATIVE			FOR "HDI" HEAVY-DUTY STEAM COIL			
			FOR CITY OF GRAND ISLAND			
			CUST: COMBUSTION ENGINEERING, INC.			
			CET PO NO 187180			
			CELL CONTRACT 13477			
			SALES ORDER NO. 78-30268			
			SIZE			
			DRAWING NUMBER			
			C 83-CD-4233			
			REV.			

AMERICAN STANDARD INDUSTRIAL PRODUCTS DIVISION

OCT 11 1978

83CD4020 83-CD-4119

2

3

4

46-04

RECEIVED
FEB 10 1982
CIVIL DEPT.

GRAND ISLAND 77-8 #58

PLATTE GENERATING STATION
Miscellaneous General Construction
Contract 77-8-58

BOILER STEAM COIL REMOVAL MONORAIL

- 1 - Shaw Box (Dresser Industries) Model #110114-20M electric cable hoist of 2,000# capacity (Note: This is the new trade name and model number for the hoist and trolley described in the above specifications). The hoist has 50'-0" lift at 16 FPM, single speed. The trolley is 100 FPM, single speed. The hoist and trolley have Nema 3R control enclosures for weatherproof operation at 460V, three phase, 60Hz. Hoist will be controlled by a column mounted 4-button Nema 3R control. Power and control shall be supplied to hoist by means of a cable festoon system, with a 4-conductor #12 AWG flat cable for power and an 8-conductor #16 AWG flat cable for controls.

115V

BOILER FEED PUMP VALVE OPERATOR MONORAIL

- 2 - Budgit Model 5252 Swing Truck Low Headroom Trolley Hoist of 1,000# capacity. Lift shall be 15 feet. Maximum elevation of the bottom of the hook shall be within seven inches of bottom of monorail. This unit is being factory modified to operate on the S4x7.7 as specified.

Proj. _____ No. <u>571</u>	LUTZ, DAILY & BRAIN	
TRANSMITTAL NO. <u>9A</u>	Consulting Engineers	
We certify that to the best of our knowledge the equipment and/or materials covered by this transmittal conform in all respects to the contract plans and specifications except as noted and described hereon or on the transmittal form.	APPROVED *	DATE
	APPROVED AS NOTED	FEB 16 1982
	RETURNED FOR CORRECTION	
By <u>K. Larsen</u>	FOSTER WESTERN, INC.	
* Approved for Compliance with Engineers Plans and Specifications. Approval does not void any part of contract or guarantee detailed quantities or dimensions.		

SHAW-BOX SERIES 800

The cutaway at right illustrates the power plant of this rugged hoist line. Standard features include heavy sectioned steel frame weldment, stress relieved to remove distortion, powerful motor drive and gear train arrangement, dual brake reliability, and all-steel suspension lug. Little wonder these hoists have earned the reputation of being the first choice of the Maintenance Man.

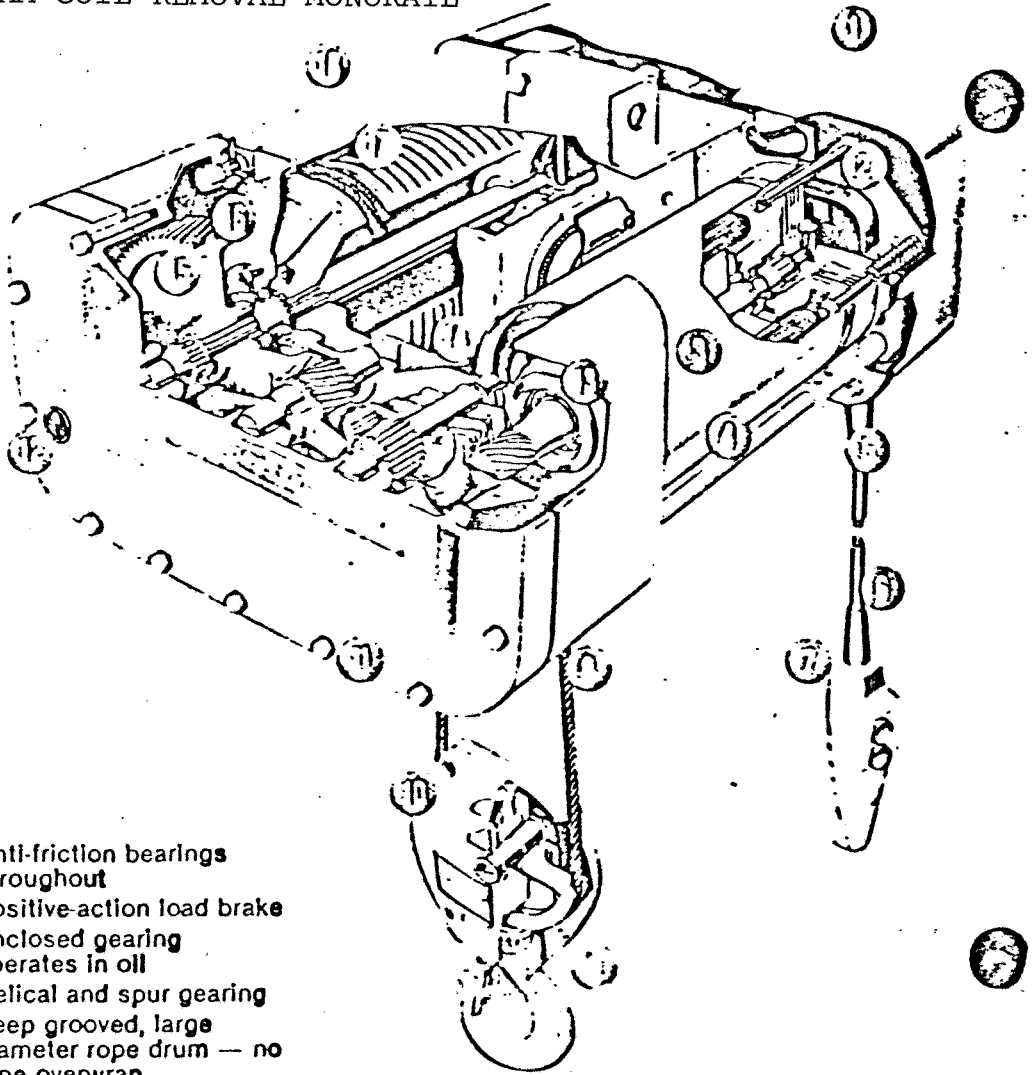

FEATURES

1. Centralized electrical system
2. Multiple disc motor brake
3. Hi-torque, heavy-duty reconnectable motor
4. Block operated upper limit stop
5. Built-in strain reliever
6. Convenient one-hand pushbutton control
7. 115-volts at pushbutton
8. Improved plow steel pre-formed wire rope
9. Full-swiveling, forged alloy steel, heat-treated hook with hook latch
10. Shrouded lower block
11. Alloy aluminum gear case and cover
12. Oil level sight gauge
13. Anti-friction bearings throughout
14. Positive-action load brake
15. Enclosed gearing operates in oil
16. Helical and spur gearing
17. Deep grooved, large diameter rope drum — no rope overwrap
18. Rugged steel frame weldment

THREE REDUCTION GEARING
Combination of precision cut, heat-treated, alloy steel helical and spur gears operates in bath of oil; provides quiet running gear train. Anti-friction bearings throughout.

DEAD END ROPE ANCHOR
Easily accessible dead end fitting securely anchors rope compression thimble fitting.

ELECTRICAL COMPARTMENT
All electrical components (except motor and pushbutton) are conveniently housed in a dust resistant electrical compartment. Removal of cover affords quick accessibility.

UPPER LIMIT STOP
For additional protection of operator, hoist, and load a positive acting, block operated limit stop is provided to prevent overtravel of lower block in raising direction.

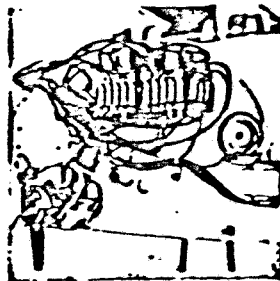
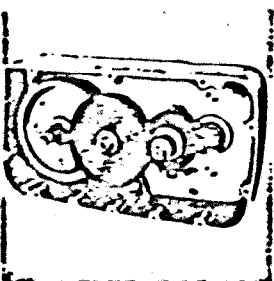

The Series 800 SHAW-BOX Wire Rope Hoists are available in both electrical and air powered models. Comprised of two basic models (Single Reeving and True Vertical Lift) their modular design provides an unusually wide choice of lifting speeds, lifts, and control. This advantage makes it possible to select the correct hoist best suited for the job at hand. No need to apply more hoist than is needed, nor settle for less hoist than is required.

This heavy-duty wire rope and drum-type hoist line has a steel mounting lug to permit mounting the hoist to a rigid overhead structure or mounted on any of the SHAW-BOX Trolleys illustrated below (patented track carrier not illustrated).

The Series 800 is also available with an optional built-in mechanical overload protection device (Weight Watcher®). Refer to Standard Options and Accessories page for a complete list of options.

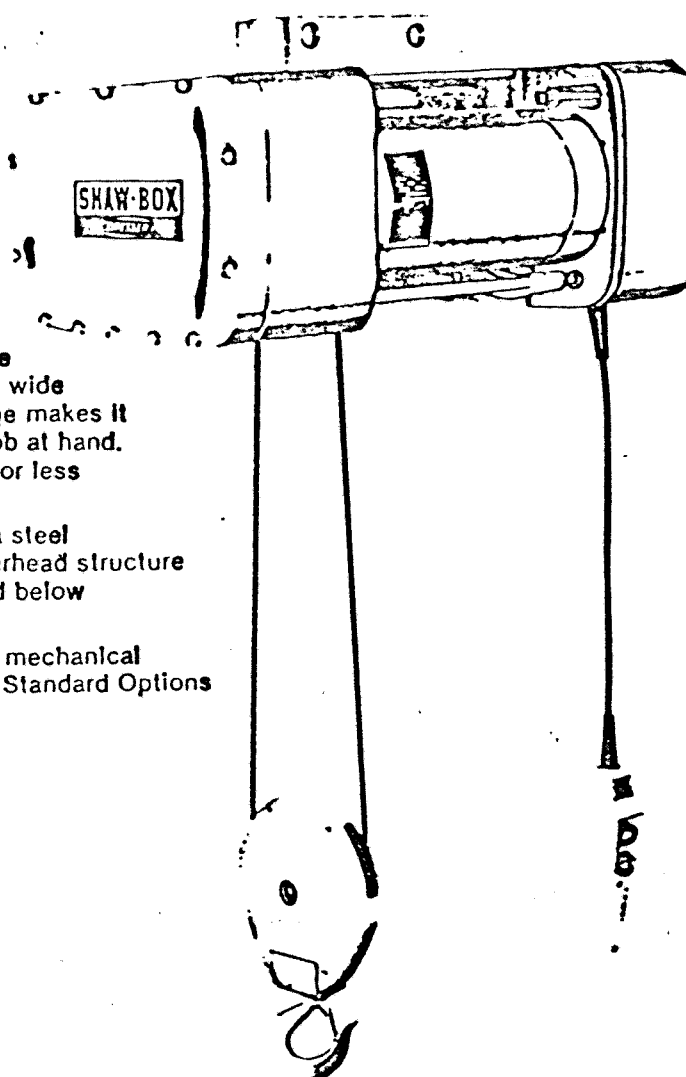

SPECIFICATIONS

CAPACITY RANGE: ½, 1, 2, 3 and 5 Tons

LIFT: 14-50 Feet

LIFTING SPEEDS: 6-60 FPM

AC CURRENT: 230/460-3-60
(Reconnectable)
208 and 575-3-60

CONTROL: Single Speed
Two Speed

SUSPENSION: Lug, Push Trolley, Ha Geared Trolley, Motor Driven Trolley (Electric Only), Patented Track Carrier

LUG SUSPENSION

This type suspension permits hoist to be permanently mounted in a fixed location. Mounting bolts are not included.

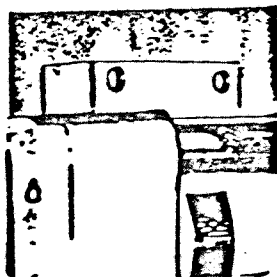

PUSH TROLLEY SUSPENSION

SHAW-BOX Push Trolleys are used for mounting hoists on I-beam tracks or single girder crane bridges. A popular suspension for hoists under 3-ton capacity.

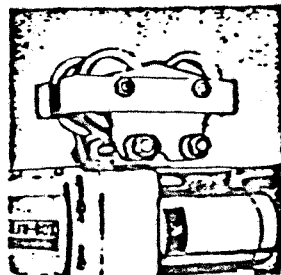

HAND GEARED TROLLEY SUSPENSION

SHAW-BOX Hand Geared Trolleys should be used on I-beam tracks or single girder crane bridges when accurate spotting of loads is essential or operator should not be in contact with load.

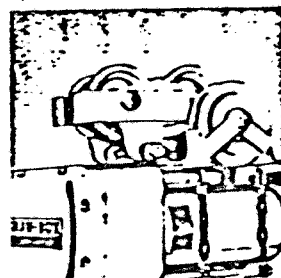

MOTOR DRIVEN TROLLEY SUSPENSION (Electric Hoists Only)

SHAW-BOX Motor Driven Trolleys for use on I-beam tracks or single girder crane bridges. Ideally suited where long distances must be traveled and speed is important.

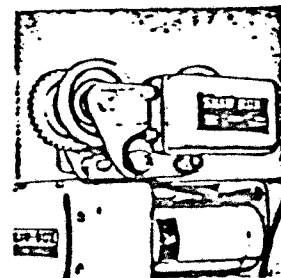

46-05

GRAND ISLAND 77-8 #58

RECEIVED
FEB 19 1982
CIVIL DEPT.

PLATTE GENERATING STATION
Grand Island, Nebraska
MISC. GENERAL CONSTRUCTION
Contract No. 77-8-58

Festooning System
BOILER STEAM COIL REMOVAL MONORAIL

One) Duct-O-Bar heavy duty, trolley supported, festoon cable electrification system, including the following components:

Heavy duty aluminum alloy track, track joint kit, 2½" angle mounting brackets, track hangers, end clamps, end stop, plated steel trolleys with kick-up rollers, tow arm, 4 conductor #12 AWG flat cable for power, 8 conductor #16 AWG flat cable for controls, and a 4-button Nema 3R control station.

Note: Push button station being furnished is shown as pendant type per the attached literature. This station, however, will be provided with conduit hub, and shall be suitable for permanent mounting to the column as specified.

LUTZ, DAILY & BRAIN <i>Consulting Engineers</i> SHAWNEE MISSION, KANSAS		
APPROVED *	DATE FEB 22 1982	BY CAC
APPROVED AS NOTED		
RETURNED FOR CORRECTION		
* Approved for Compliance with Engineers Plans and Specifications. Approval does not void any part of contract or guarantee detailed quantities or dimensions.		

Proj: _____ No. 571

TRANSMITTAL NO. 5A

We certify that to the best of our knowledge the equipment and/or materials covered by this transmittal conform in all respects to the contract plans and specifications except as noted and described hereon or on the transmittal form.

FOSTER WESTERN, INC.

By K. Lawson

RUBBER ENCLOSED PENDANT PUSH BUTTON STATIONS ROUND FLEXIBLE CONTROL CABLES AND PLUG-IN PENDANT CABLE ASSEMBLIES

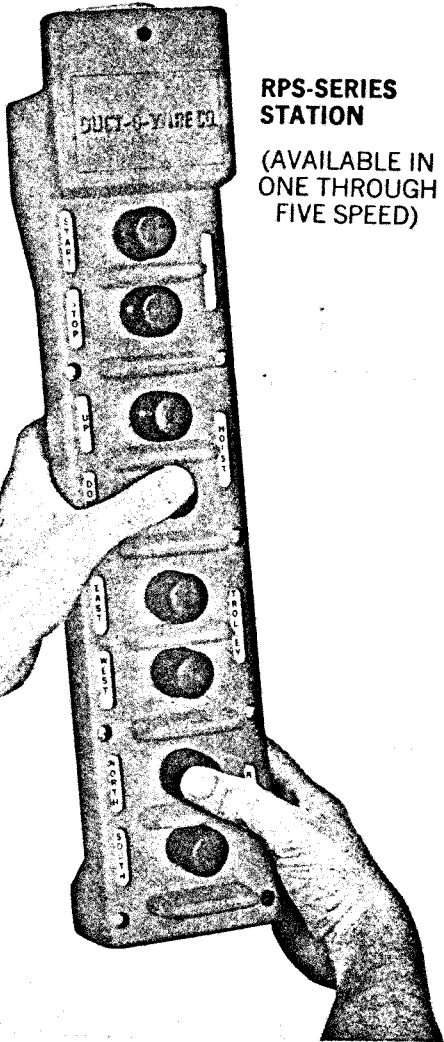

**RPS-SERIES
STATION**
(AVAILABLE IN
ONE THROUGH
FIVE SPEED)

AUTOMATIC SERVICES
P.O. BOX 1283 PH. 309-794-0557
ROCK ISLAND, ILL. 61201

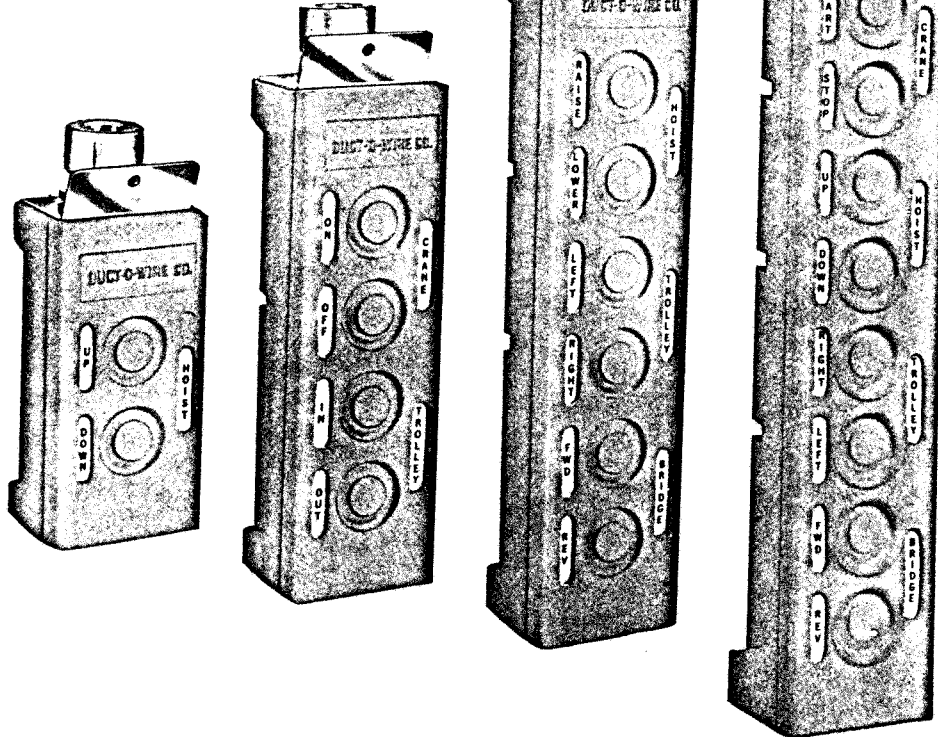

RPB-SERIES STATIONS
(AVAILABLE IN ONE AND 2 SPEED)

COMPACT ENCLOSURE RATED NEMA 1, 3, 4, & 12 WITH THESE OUTSTANDING FEATURES

- ... Rugged steel reinforced rubber case of high visibility yellow color.
- ... Easy to read snap-in nameplates
- ... Strain relief for cable and cord grip furnished on all assemblies.
- ... Grounded connection of all internal metal parts
- ... Easy accessibility for wiring

RPB-SERIES SWITCHES ARE  LISTED

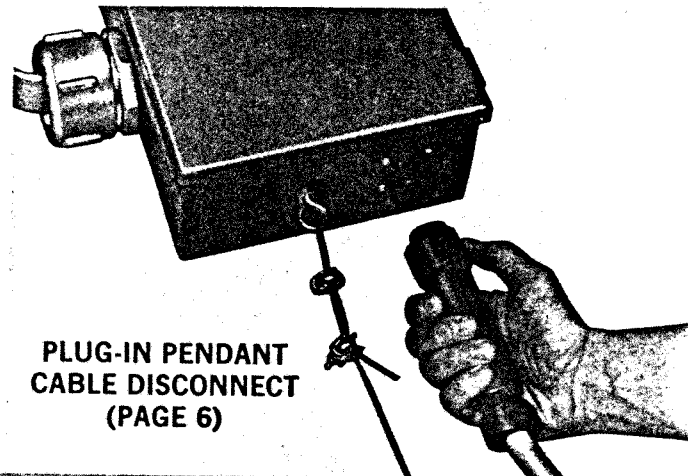

**PLUG-IN PENDANT
CABLE DISCONNECT
(PAGE 6)**

MANUFACTURED BY

Duct-O-Wire Company

Box 519
Box 846

Corona, Calif. 91720
Waukesha, Wis. 53187
Oakville, Ont., Canada
Page 43 of 49

(714) 735-8220
(414) 544-4944
(416) 844-1791

Telex: 67-6320
Telex: 26-9531
Telex: 06-982296

© COPYRIGHT 1977 By DUCT-O-WIRE CO.
PRINTED IN U.S.A. REVISED 1981

Brochure No. PB-81C
(Supersedes #PB-81B)

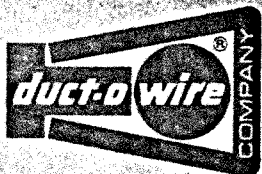

RPB-SERIES ONE AND TWO SPEED RUBBER ENCLOSED PENDANT PUSH BUTTON STATIONS

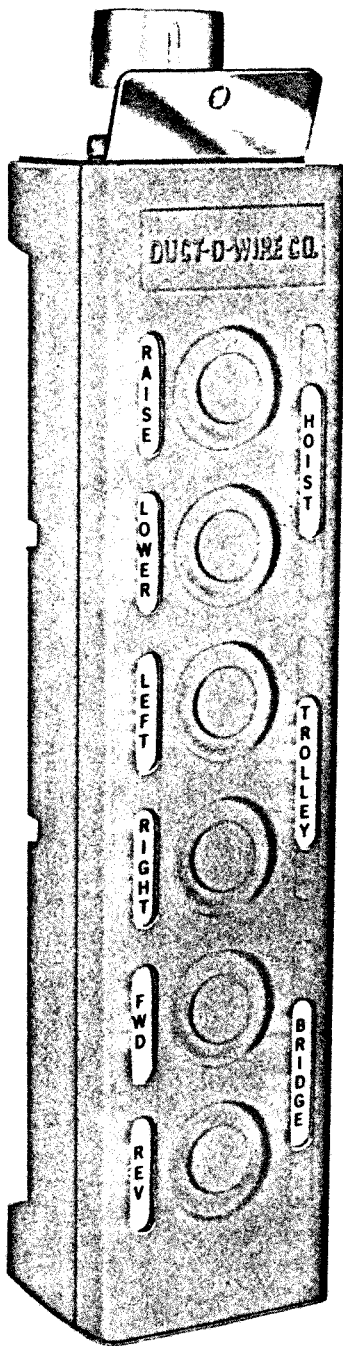

Catalog Number	Description	Enclosure Size
COMPLETE PENDANT STATIONS		
RPB-1-1	Two button — All 1 speed	2 Button
RPB-1-2A*	Two button — All 2 speed	2 Button
RPB-1-1M	Two button — 1 speed w/on-off switch	4 Button
RPB-1-2AM	Two button — 2 speed w/on-off switch	4 Button
RPB-2-1	Four button — All 1 speed	4 Button
RPB-2-2A*	Four button — All 2 speed	4 Button
RPB-2-1M	Four button — 1 speed w/on-off switch	6 Button
RPB-2-2AM	Four button — 2 speed w/on-off switch	6 Button
RPB-3-1	Six button — All 1 speed	6 Button
RPB-3-2A*	Six button — All 2 speed	6 Button
RPB-3-1M	Six button — 1 speed w/on-off switch	8 Button
RPB-3-2AM	Six button — 2 speed w/on-off switch	8 Button
RPB-4-1	Eight button — All 1 speed	8 Button
RPB-4-2A*	Eight button — 6-2 speed and 2-1 speed	8 Button
ACCESSORIES		
RPB-PL	Pilot Light — 115 V.A.C.	
RPB-TS	Duplex TIE Straps (pair)	
RPB-MG-1	Wire mesh cord grip in lieu of standard cord grip furnished — specify cable O.D. for 2, 4, or 6 button stations	
RPB-MG-2	Same as above except for 8 button station — specify cable O.D.	
BUTTONS & ENCLOSURES ONLY		
RB-1	Single Speed button with mounting brackets	
RB-2A*	Two speed button with mounting bracket — cumulative type	
RP-1	Two button enclosure with cord grip	
RP-2	Four button enclosure with cord grip	
RP-3	Six button enclosure with cord grip	
RP-4	Eight button enclosure with cord grip	
RPB-6A1	Maintained push — push on-off (switch only)	
REPLACEMENT PARTS		
RP-1F	Front cover only — 2 button	
RP-2F	Front cover only — 4 button	
RP-3F	Front cover only — 6 button	
RP-4F	Front cover only — 8 button	

START/STOP BUTTONS — Single speed push buttons include normally open and normally closed contacts for start/stop and electrical interlock wiring connections. Two speed switches have two normally open contacts only.

NAMEPLATES — Package of snap-in nameplates is included with each pendant station unless specific marking is requested on order.

***TWO SPEED BUTTONS**

Standard two speed buttons have cumulative type "make-make" contacts. If non-cumulative "break before make" type switches are required, drop the suffix "A" in catalog number and specify accordingly.

Easy accessibility for wiring of push buttons.

RPB SWITCH CONTACT RATING!

Voltage	AC Current	DC Current
28	10 Amps	10 Amps
125	10	.5

DESCRIPTION	DIMENSIONS			WEIGHT	ACCOMODATES CORD FROM
	WIDTH	DEPTH	LENGTH		
Two Button Enclosure	3"	2-1/2"	5-3/4"	1-3/4 lbs.	.500-.625 Dia.
Four Button Enclosure	3"	2-1/2"	9"	2-3/4 lbs.	.500-.625 Dia.
Six Button Enclosure	3"	2-1/2"	12-3/8"	3-1/2 lbs.	.563-.687 Dia.
Eight Button Enclosure	3"	2-5/8"	15-3/4"	4-1/4 lbs.	.625-.750 Dia.

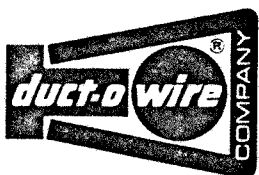

MANUFACTURERS OF SAFETY ENCLOSED
CONDUCTOR SYSTEMS AND PENDANT PUSH
BUTTON STATIONS
FOR ... Cranes ... Hoists ... other industrial applications.

BOILER STEAM COIL REMOVAL MONORAIL
 FESTOONING SYSTEM
 PLATTE GENERATING STATION 77-8-58
 GRAND ISLAND, NE. 2/10/82

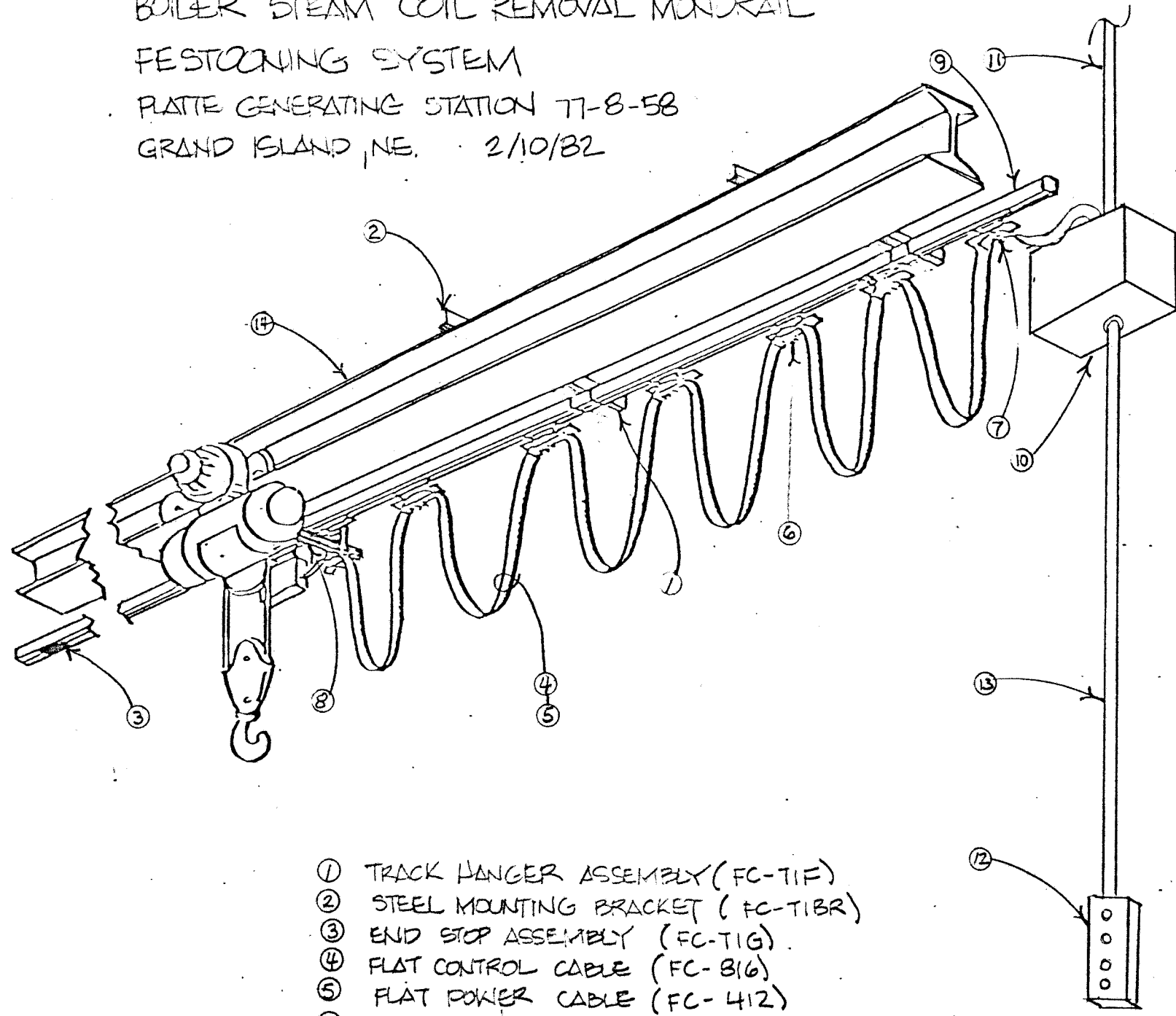

- ① TRACK HANGER ASSEMBLY (FC-T1F)
- ② STEEL MOUNTING BRACKET (FC-T1BR)
- ③ END STOP ASSEMBLY (FC-T1G)
- ④ FLAT CONTROL CABLE (FC-816)
- ⑤ FLAT POWER CABLE (FC-412)
- ⑥ TROLLEY & CABLE SADDLE ASSEMBLY (FC-TR6)
- ⑦ END CLAMP & CABLE SADDLE ASSEMBLY (FC-T1C)
- ⑧ TOW BAR (FC-TB4)
- ⑨ HEAVY DUTY TRACK (FC-T1A)
- ⑩ JUNCTION BOX
- ⑪ POWER PROVIDED BY OTHERS - 460 V, 3 PHASE
- ⑫ PUSH BUTTON STATION MOUNTED TO COL. BLD-BL2
- ⑬ RIGID CONDUIT
- ⑭ TROLLEY BEAM BY OTHERS - 510 x 25.4

DUCT-O-WIRE

FESTOONING SYSTEMS

AUTOMATIC SERVICES
P.O. BOX 1283 PH. 309-794-0557
ROCK ISLAND, ILL 61201

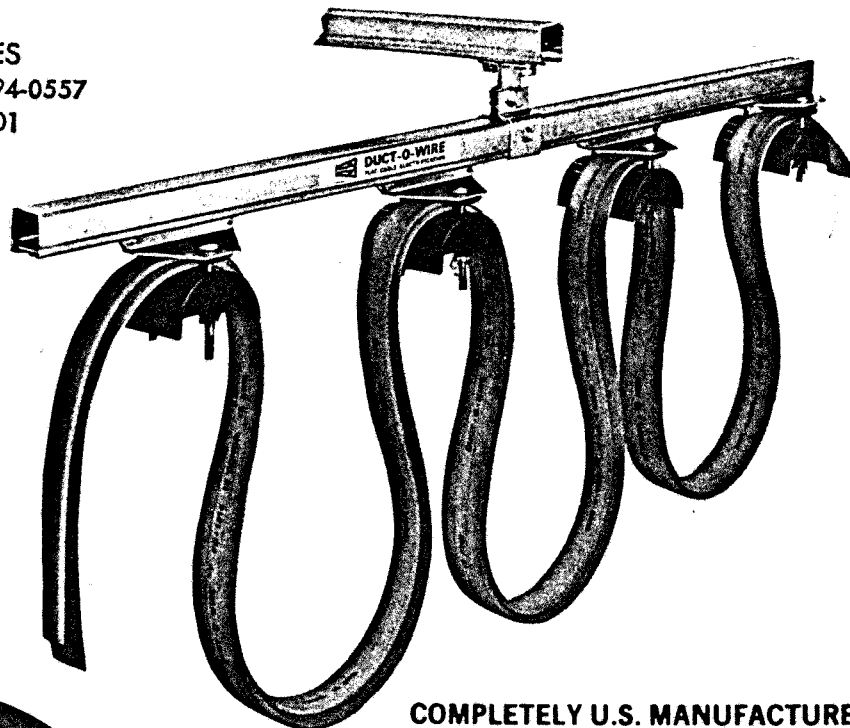

COMPLETELY U.S. MANUFACTURED SYSTEMS FOR CRANES, HOISTS, AND OTHER INDUSTRIAL APPLICATIONS ...

OUTSTANDING FEATURES ...

- ... Heavy gage galvanized steel track
- ... Steel ball bearing trolley wheels
- ... Extra flexible flat power and control cables with bright yellow jackets
- ... Bolted "clamp type" track joints and hangers assure positive alignment and rigidity of the track system
- ... Unique flat cable design allows linear extension of the cable — no coiling required for contraction
- ... All wires are color coded for easy wiring per NEMA



LISTED CABLE SIZES AVAILABLE — 600 VOLTS — 105°C

SAFE ... DEPENDABLE ... LOW COST

File #E65459

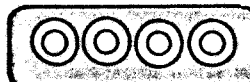

- 4 Condr. #14 AWG
- 4 Condr. #12 AWG
- 4 Condr. #10 AWG
- 4 Condr. #8 AWG
- 4 Condr. #6 AWG
- 4 Condr. #4 AWG
- 4 Condr. #2 AWG



- 8 Condr. #16 AWG
- 8 Condr. #14 AWG
- 7 Condr. #12 AWG

DUCT-O-WIRE SYSTEMS ARE DESIGNED BEYOND THE FESTOON CONCEPT ...

- ... Specifically designed for the rugged, heavy duty use of overhead cranes and hoists.
- ... Flat cables reduce bending radius and insure longer life than round cables when exposed to continuous flexing.
- ... Components available for complete system package including Duct-O-Wire's rubber enclosed pendant push button stations.



- 12 Condr. #16 AWG
- 12 Condr. #14 AWG

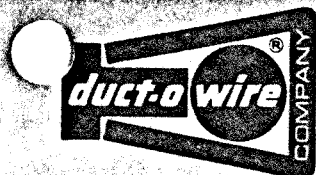

MANUFACTURED BY

Duct-O-Wire Company

Box 519
Box 846

Corona, Calif. 91720
Waukesha, Wis. 53187
Oakville, Ont., Canada

(714) 735-8220
(414) 544-4944
(416) 844-1791

Telex: 67-6320
Telex: 26-9531
Telex: 06-982296

Page 46 of 49

DUCT-O-WIRE FLAT CABLES AND CONNECTORS



4 Condr. #14 AWG
 4 Condr. #12 AWG
 4 Condr. #10 AWG
 4 Condr. #8 AWG
 4 Condr. #6 AWG
 4 Condr. #4 AWG
 4 Condr. #2 AWG

8 Condr. #16 AWG
 8 Condr. #14 AWG
 7 Condr. #12 AWG



12 Condr. #16 AWG
 12 Condr. #14 AWG



CATALOG NUMBER	WEIGHT	DESCRIPTION
		Flat Cable — 600 Volts — PVC Jacketed Extra flexible with yellow outer jacket (Operating Temperature range — 35°C to + 105°C)
FC-42	.95#/Ft.	4 Conductors — #2 AWG Rating: 120 AMPS @ 30°C ambient temperature
FC-44	.75#/Ft.	4 Conductors — #4 AWG Rating: 90 AMPS @ 30°C ambient temperature
FC-46	.58#/Ft.	4 Conductors — #6 AWG Rating: 70 AMPS @ 30°C ambient temperature
FC-48	.45#/Ft.	4 Conductors — #8 AWG Rating: 50 AMPS @ 30°C ambient temperature
FC-410	.24#/Ft.	4 Conductors — #10 AWG Rating: 40 AMPS @ 30°C ambient temperature
FC-412	.16#/Ft.	4 Conductors — #12 AWG Rating: 30 AMPS @ 30°C ambient temperature
FC-414	.12#/Ft.	4 Conductors — #14 AWG Rating: 25 AMPS @ 30°C ambient temperature
FC-712	.29#/Ft.	7 Conductors — #12 AWG Rating: 21 AMPS @ 30°C ambient temperature
FC-814	.22#/Ft.	8 Conductors — #14 AWG Rating: 17 AMPS @ 30°C ambient temperature
FC-816	.18#/Ft.	8 Conductors — #16 AWG Rating: 15 AMPS @ 30°C ambient temperature
FC-1214	.34#/Ft.	12 Conductors — #14 AWG Rating: 17 AMPS @ 30°C ambient temperature
FC-1216	.28#/Ft.	12 Conductors — #16 AWG Rating: 15 AMPS @ 30°C ambient temperature

POWER

CONTROL

Required length — Track length + 10% + length required for end connections.

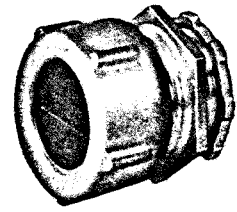

CATALOG NUMBER	WEIGHT	DESCRIPTION
		Flat Cable Connector (Cord Grip)
FC-4/8C	.50#	Connector with bushing for FC-410 and 1 - 8 condr. cable (1¼" NPS)
FC-44C	.80#	Connector with bushing for FC-44 cable (2" NPS)
FC-46C	.50#	Connector with bushing for FC-46 flat cable (1½" NPS)
FC-410C	.22#	Connector with bushing for FC-410 Cable (1" NPS)
FC-412C	.22#	Connector with bushing for FC-412 & FC-414 cable (1" NPS)
FC-816C	.50#	Connector with bushing for FC-814 & FC-816 cable (1¼" NPS)
FC-816C2	.50#	Connector with bushing for 2 - 8 conductor cables, 1-FC-48 cable, or for FC-712 flat cable (1¼" NPS)
FC-1216C	.75#	Connector with bushing for FC-1214 & FC-1216 cable (1½" NPS)
FC-1216C2	.75#	Connector with bushing for 2 - 12 conductor cables (1½" NPS)
FC-1216C3	.75#	Connector with bushing for 3 - 12 conductor cables (1½" NPS)
		One required for each end of each cable length
		Economy cable clamps (not weatherproof) are also available — Consult factory

SHORT TIME CURRENT RATINGS FOR PVC FLAT CABLES

FLAT CABLE RATINGS GIVEN ABOVE ARE FOR CONTINUOUS DUTY. THE FOLLOWING ARE SHORT TIME RATINGS FOR CRANE & HOIST MOTORS PER ARTICLE 610 OF THE 1978 NATIONAL ELECTRICAL CODE FOR 90°C CABLES.

CABLE		SHORT TIME RATING	
		60 MIN.	30 MIN.
#FC-42	4 Conductors — #2 AWG	148 AMPS	173 AMPS
#FC-44	4 Conductors — #4 AWG	111 AMPS	130 AMPS
#FC-46	4 Conductors — #6 AWG	83 AMPS	94 AMPS
#FC-48	4 Conductors — #8 AWG	63 AMPS	69 AMPS
#FC-410	4 Conductors — #10 AWG	49 AMPS	52 AMPS
#FC-412	4 Conductors — #12 AWG	36 AMPS	40 AMPS
#FC-414	4 Conductors — #14 AWG	31 AMPS	32 AMPS

DUCT-O-WIRE FLAT CABLE DE-RATING FACTORS FOR AMBIENT TEMPERATURES ABOVE 30°C FULL LOAD CURRENT RATING (PER ARTICLE 310-16 OF THE 1978 NATIONAL ELECTRICAL CODE)

AMBIENT TEMPERATURE	CURRENT CORRECTION FACTOR
°C	
30	1.00 (Full Load Current Rating)
50	.82
75	.50
90	.11
°F	
86	
122	
167	
194	

HEAVY DUTY FESTOON CABLE SYSTEM INSTALLATION DIMENSIONS

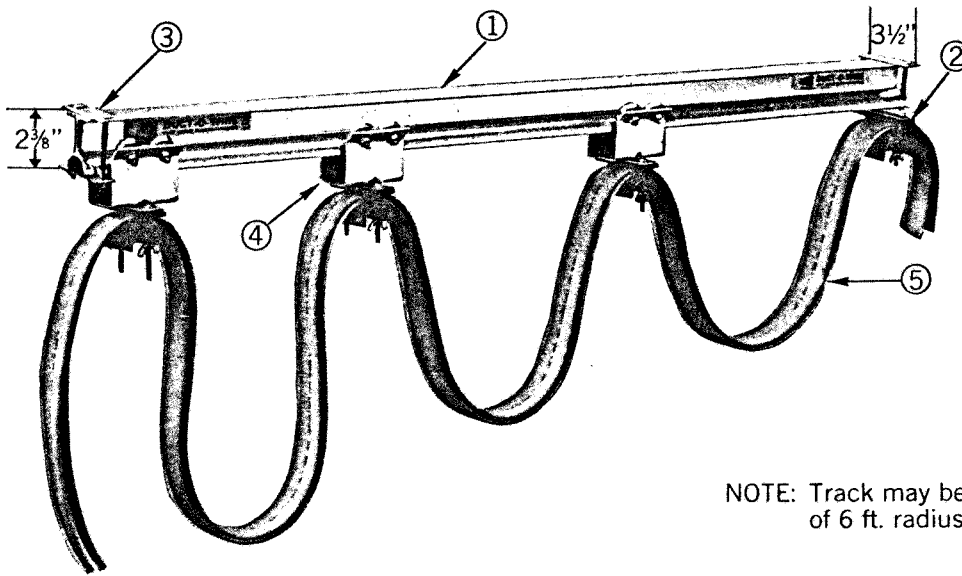

- ① Heavy Duty Track
- ② End Clamp Assembly
- ③ End Stop Assembly
- ④ Trolley/Saddle Assembly
- ⑤ Flat Cables

NOTE: Track may be factory bent into 90° max. curve of 6 ft. radius or more — consult factory.

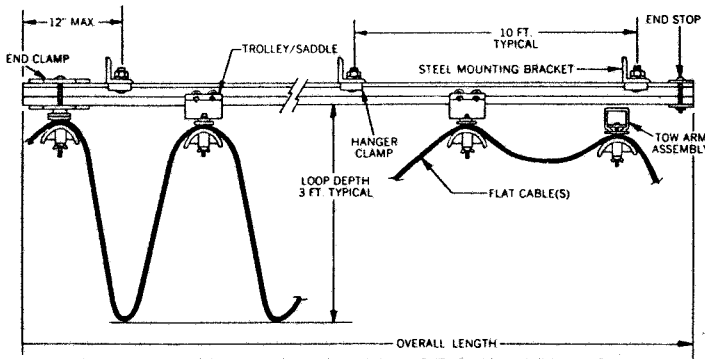

FIGURE 1 — STANDARD METHOD OF SUPPORTING TRACK USING HANGER CLAMPS

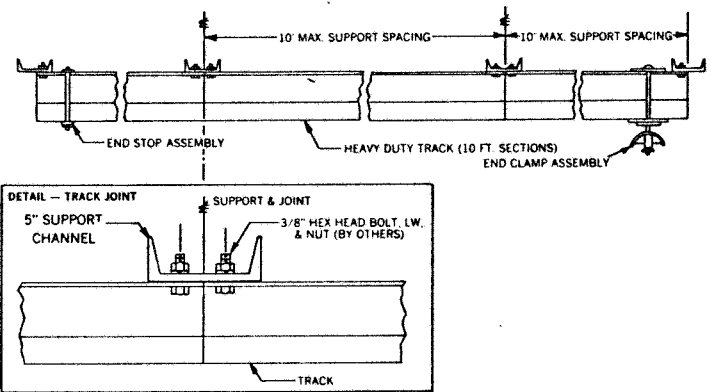

FIGURE 2 — ALTERNATE METHOD OF SUPPORTING TRACK BY BOLTING DIRECT TO SUPPORT CHANNEL — THIS METHOD IS RECOMMENDED WHEN PRACTICAL

SUPPORTING TRACK SECTIONS

a. Using either of the above mounting methods, install and join the track sections either at a support (Figure 2) or by using hanger clamp assemblies (Figure 3) and bolted joint assemblies (Figure 4).

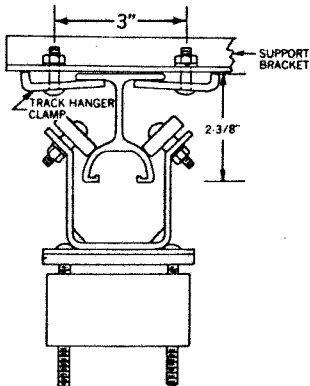

FIGURE 3 — DETAIL TRACK HANGER CLAMP ASSEMBLY

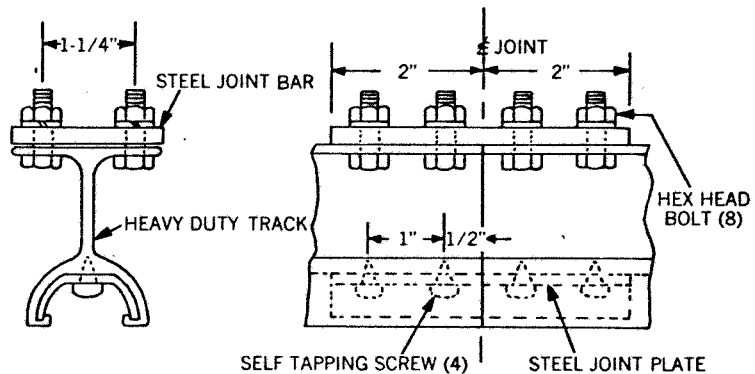
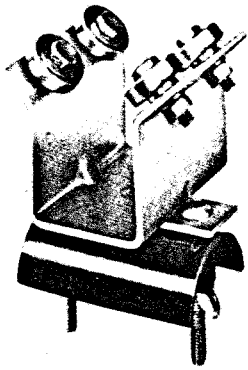

FIGURE 4 — DETAIL TRACK JOINT ASSEMBLY
(NOTE: JOINT TO BE LOCATED AS CLOSE TO A SUPPORT POINT AS POSSIBLE)

b. File any uneven or rough joints.

HEAVY DUTY FESTOON CABLE SYSTEM AND PIPE SUPPORTED TROLLEY SYSTEM



CAT. NO. #FC-TR7
STANDARD TROLLEY

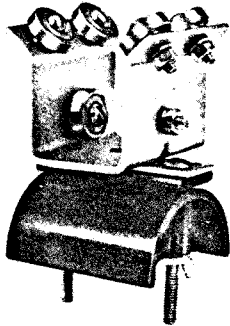

CAT. NO. #FC-TR6Z
TROLLEY WITH ANTI-LIFT ROLLERS

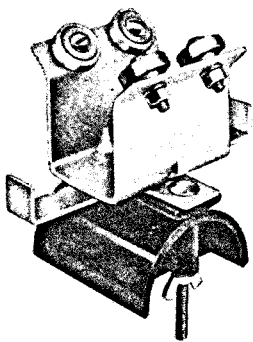

CAT. NO. #FC-TR6X
TROLLEY WITH 6" BUMPER PLATE

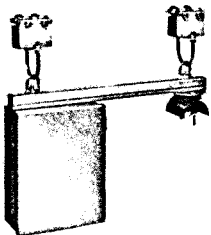
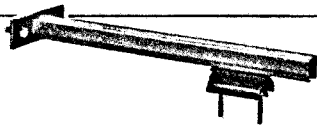

CATALOG NUMBER	WEIGHT	DESCRIPTION
FC-T1A	1.0#/Ft.	HEAVY DUTY TRACK High Strength Aluminum Alloy available in 10 ft. or 20 ft. sections.
FC-T1D	1.0#	TRACK JOINT KIT Joint Bars and Hardware for joining adjacent Track sections.
FC-T1BR	10#	STEEL MOUNTING BRACKET 2½" x 2½" Angle (Primer Coated and Punched) — 36" Long
FC-T1CH	10#	5" Support Channel per Figure 2, Page 8.
FC-T1F	.9#	TRACK HANGER KIT Consists of 2 clamps and fasteners to mount to support bracket. (10 ft. max. support spacing)
FC-T1C	.4#	END CLAMP/SADDLE ASSEMBLY To secure Cables at cable storage end of Track.
FC-T1G	.2#	END STOP ASSEMBLY (1 required per system)
FC-TR6	1.20#	STANDARD TROLLEYS FOR FLAT CABLES Plated steel trolley with 4 steel ball bearing trolley wheels, large cable saddle, and all hardware. Capacity: Up to 5 Cables - #10 AWG Max. or 2 Cables - #4 AWG Max.
FC-TR6-BR	1.20#	Same as above except stainless steel with brass trolley wheels and stainless steel hardware.
FC-TR6-SS	1.20#	Same as above except stainless steel with stainless steel trolley wheels and hardware.
FC-TR7	1.10#	Plated steel trolley with 4 steel ball bearing trolley wheels, small cable saddle, and all hardware. Capacity: Up to 2 Cables - #10 AWG Max.
FC-TR7-BR	1.10#	Same as above except stainless steel with brass trolley wheels and stainless steel hardware.
FC-TR7-SS	1.10#	Same as above except stainless steel with stainless steel trolley wheels and hardware.
<p>FOR 6" TROLLEYS WITH FORMED STEEL BUMPERS — ADD SUFFIX "X" TO CATALOG NUMBER OF TROLLEY DESIRED (#4 AWG OR LARGER CABLE). FOR ANTI-LIFT ROLLERS ON TROLLEYS — ADD SUFFIX "Z" TO CATALOG NUMBER OF TROLLEY DESIRED FOR ALL CURVED SYSTEMS AND SPEEDS OVER 150 FPM.</p>		
FC-TB4	3.25#	TOW ARM FOR FLAT CABLES Steel tow arm with cable saddle. Arm is 18" long and saddle is adjustable along the arm length.
FC-TRC6	5.10#	CONTROL TROLLEY FOR FLAT CABLES Two trolleys swivel mounted to steel channel for support of junction box. (Junction box not included).
FC-BX1	7.5#	8" x 10" x 4" Junction box
FC-BXT	.60#	12 Pole terminal strip (up to 2 per box)